

# Wisconsin Electric Machines and Power Electronics Consortium

RESEARCH REPORT  
89-1

MEASUREMENT AND COMPUTATION OF STARTING TORQUE PULSATIONS  
OF SALIENT POLE SYNCHRONOUS MOTORS

J.O. Ojo, T.A. Lipo  
University of Wisconsin  
Madison WI

V. Ostovic  
University of Akron  
Akron OH

J.C. White  
Elec. Power Res. Institute  
Palo Alto CA

## WEMPEC

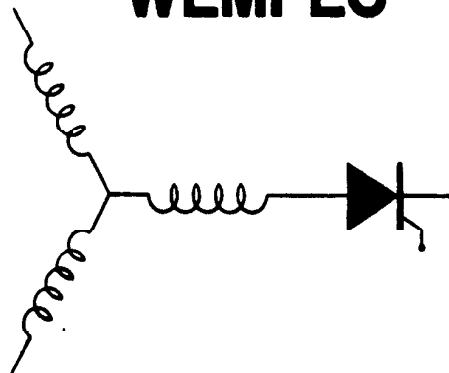

Department of Electrical and Computer Engineering  
1415 Johnson Drive  
Madison, Wisconsin 53706

# MEASUREMENT AND COMPUTATION OF STARTING TORQUE PULSATIONS OF SALIENT POLE SYNCHRONOUS MOTORS

J.O. Ojo  
Member  
University of Wisconsin  
Madison WI

V. Ostovic  
Member  
University of Akron  
Akron OH

T.A. Lipo  
Fellow  
University of Wisconsin  
Madison WI

J.C. White  
Life Fellow  
Electric Power Research Institute  
Palo Alto CA

**ABSTRACT** Five basic methods of synchronous motor torque measurement are described. Measurements of instantaneous electromagnetic torques of a medium size 25 hp salient pole synchronous motor using these methods are compared with simulation results obtained from a full order model as well as with a quasi-linear algebraic approximation. It is shown that torque measurement using search coils in the stator windings gives the best correlation with the simulation results followed by a modified terminal measurement based on terminal voltage and current. The accelerometer method gives poorest results in that it is unable to capture the low frequency components of the electromagnetic torques. It is also demonstrated by simulation that the approximate method for calculation of pulsating torques based on a quasi-linear model of the motor gives an estimate comparable to that of the full order model, particularly for large machines.

**Key Words:** Synchronous Motors, Pulsating Torque, Starting Performance.

## INTRODUCTION

Synchronous motors are commonly used as prime movers in high power applications where the horsepower rating of the machine exceeds its corresponding RPM (revolution per minute) rating. Such applications frequently occur in large turbocompressor, fan and pump installations. Synchronous motors continue to be a desirable alternative in such applications because their reactive power can be readily controlled and because they have relatively higher efficiencies compared to a.c. induction and d.c. motors. However, in addition to producing asynchronous accelerating torques during a direct on-line start, salient pole synchronous motors generate oscillating torques at double slip frequency due to asymmetry of rotor electrical and magnetic circuits. These pulsating torques can incite resonance with the connected mechanical systems. The asymmetry of the rotor circuits also typically causes a loss of average torque above half speed. This reduction in average torque, which is detrimental to the starting performance of the motor, is the result of the backward traveling component of the air gap flux interacting with the stator circuit and creates a braking torque as well as a dip in the average torque slightly above half speed often referred to as the *George Effect*.

In general the synchronous motor and the connected load can be represented by a system of interconnected springs and masses. As in any mechanical system, resonances occur at the system natural frequencies. For a drive system comprising a synchronous motor and turbocompressor, the first natural frequency lies between 5 and 30 Hz. Mechanical systems that are inherently flexible are sensitive to impressed pulsating torques which may excite the system at one or more of the mechanical resonance frequencies. This problem is especially pronounced when a salient pole synchronous motor is used as a prime mover, since the torque produced by a synchronous motor sweeps the frequency range from zero to twice the supply frequency as it accelerates from rest during starting. Overstressed shafts and couplings, abnormal gear tooth wear and other hazards can result when a motor and equipment coupled to it are subjected to torsional oscillation.

Optimum starting performance of a synchronous motor drive system is achieved by making the electrical pulsating torques as small as possible in the region of the first natural frequency while at the same time providing a high starting torque in the speed range of the critical resonance area. Although the magnitude of the pulsating torque varies depending on the design parameters of the rotor, it cannot be eliminated by design optimization in any practical type of salient pole synchronous machine. Furthermore, the reductions in the magnitude of the pulsating torques that are theoretically possible often cannot be obtained in practice because of the need to meet other requirements such as heating limitations. In practice, resonance of a synchronous motor drive is eliminated by design of the external equipment to which it is mechanically connected by changing the spring constants or increasing the damping of the coupling using a special gear, intermediate shafts or with a highly flexible coupling.

In view of the hazards that can result due to the interaction between impressed pulsating torques and connected mechanical loads, computational and measurement facilities are required to measure and calculate these torques with a view to augment and enhance design processes of these drives. In general, electromagnetic torques can be measured by either mechanical and electrical methods. However electrical methods have greater fidelity as they are able not only to efficiently measure static torques but also instantaneous torques.

Thus far, a variety of papers have been written suggesting various practical measurement techniques for instantaneous torque [1-6]. However, little attention has been paid to quantify and compare the errors inherent in these methods. In this paper five practical methods of torque measurement are described and compared. The first method is the traditional mechanical measurement using an accelerometer. The second method involves an electrical technique using search coils as flux sensors. The remaining techniques employ either terminal voltage and current or input power and speed. A new expression is proposed which yields improved results compared to previous methods.

In this paper measurements of instantaneous electromagnetic torques of a medium size 25 hp salient pole synchronous motor using these methods are compared with simulation results obtained from a full order and also with an approximate algebraic model. Comparison is made for a value of discharge field resistance of zero ohms (shorted field). However, a complete set of test results including test data for field discharge resistances of 82 and 164 ohms are given in Ref. 7. It is shown that torque measurement using search coils in the stator windings gives the best correlation with the simulation results, followed by a modified integral of the input power approach. The accelerometer method gives poorest results in that it is unable to capture the high frequency components of the electromagnetic torques. Due to cost as well as practical limitations in the implementation of the search coil measurement technique, a new method termed the modified volt-sec-ampere (MVSA) measurement is recommended for the measurement of instantaneous electromagnetic torque. It is also demonstrated in this paper by simulation that the approximate method for the calculation of pulsating torques based on a quasi-linear model of the motor gives an estimate comparable to that of the full order model, particularly for large machines.

## TORQUE COMPONENTS OF SALIENT POLE SYNCHRONOUS MOTORS

All salient pole synchronous machines develop the following major components of electromagnetic torque during starting:

(1) An average or unidirectional component. This is the useful component which acts to accelerate the machine and results from the forward rotating component of rotor currents interacting with the

symmetrical alternating component of the air gap flux linkages in much the same manner as the squirrel cage induction machine.

(2) An initial transient pulsating component which results from the initial asymmetrical component of the inrush current interacting with the symmetrical component of the air gap flux linkages. The resulting frequency of torque pulsation is essentially equal to the line frequency.

(3) A continuous pulsating component at twice slip frequency which is the result of the asymmetry of the rotor electrical and magnetic circuits.

(4) When the main field winding is excited by direct current, the electromagnetic geometry repeats once for every two poles and there exists an additional component of continuous torque pulsation at slip frequency. In most cases the field winding is shorted either across the terminals or through a field discharge resistor. Should the field excitation be applied before synchronizing speed is reached, an additional large component of pulsating torque appears with a frequency one-half that of the original component, that is slip frequency.

Pulsating electromagnetic torques which are due to rotor asymmetry are considered to be the most important detrimental pulsating torque component. These torques can arise in part from magnetic permeance variations which are the result of the salient pole being relatively easily magnetized at the center of the pole and relatively less easily magnetized at the center of the interpolar space. Pulsating torques can also be produced by rotor asymmetry due to main field windings which encircle only the direct axis and not the quadrature axis and by the variable bar span of the amortisseur or damper winding consisting of shorted bars inserted into slots in the rotor.

### D-Q EQUATIONS OF SALIENT POLE SYNCHRONOUS MACHINES

The Park's voltage equations of synchronous machines in the rotor reference frame based on the d-q theory and using the notation of Krause [8] are as follows:

$$v_{qs} = r_s i_{qs} + \frac{p}{\omega_b} \psi_{qs} + \frac{\omega_r}{\omega_b} \psi_{ds} \quad (1)$$

$$v_{ds} = r_s i_{ds} + \frac{p}{\omega_b} \psi_{ds} - \frac{\omega_r}{\omega_b} \psi_{qs} \quad (2)$$

$$v_{kq} = r_{kq} i_{kq} + \frac{p}{\omega_b} \psi_{kq} \quad (3)$$

$$v_{kd} = r_{kd} i_{kd} + \frac{p}{\omega_b} \psi_{kd} \quad (4)$$

$$v_{fd} = r_{fd} i_{fd} + \frac{p}{\omega_b} \psi_{fd} \quad (5)$$

where  $p$  denotes the time derivative operator. The quantities  $v_{kq}$  and  $v_{kd}$  are identically zero for practical machines.

The mechanical equation of motion is given as

$$J \left( \frac{2}{P} \right) p \omega_r + B_m \left( \frac{2}{P} \right) \omega_r + T_l = T_e \quad (6)$$

where  $P$  denotes the number of poles of the machine and  $\omega_r$  is the speed of an equivalent two pole machine. That is the ratio of  $\omega_r$  to  $P/2$  corresponds to the actual mechanical speed of the machine.

Finally, the electromagnetic torque  $T_e$ , is expressed either as Eq. (7) or Eq. (8)

$$T_e = \left( \frac{3P}{2\omega_b} \right) [\psi_{ds} i_{qs} + \psi_{qs} i_{ds}] \quad (7)$$

$$T_e = \left( \frac{3P}{2\omega_b} \right) [\psi_{md} i_{qs} + \psi_{mq} i_{ds}] \quad (8)$$

In Eq. 8 the subscripts  $md$  and  $mq$  denote the mutual or air gap portions of the d-q axes flux linkages.

### APPROXIMATE TORQUE EQUATION OF SALIENT POLE SYNCHRONOUS MACHINES

In general, the above equations can be solved only by implicit integration since they are non-linear. If the speed is assumed constant, linear analysis techniques can clearly be applied. However, during the starting period it is apparent that the speed is not necessarily constant so that linear techniques are not strictly

valid. However it is desired in practice for synchronous motor drives to have a uniform starting process with relatively constant acceleration over the entire speed range in order to reduce loading of other connected system components. Under this condition, acceleration is uniform and relatively small so that the constant speed assumption is generally valid except for very small motors with small moments of inertia. Hence, linear techniques will generally yield acceptable engineering results. Moreover if the transient components are neglected, the motor can be assumed to be in quasi-steady state, and phasor analysis can be applied to such problems.

During steady state asynchronous operation at slip  $s$ , the d-q axis quantities pulsate at slip frequency. Equations (1) to (5) can then be expressed as follows:

$$V = r_s i_{qs} + j(1-s) \psi_{ds} + js \psi_{qs} \quad (9)$$

$$jV = r_s i_{ds} - j(1-s) \psi_{qs} + js \psi_{ds} \quad (10)$$

$$0 = js \psi_{kq} + r_{kq} i_{kq} \quad (11)$$

$$0 = js \psi_{kd} + r_{kd} i_{kd} \quad (12)$$

$$0 = js \psi_{fd} + r_{fd} i_{fd} \quad (13)$$

If the stator resistance is neglected in Eqs. (9) and (10) and Eqs. (11) to (13) are divided by the slip  $s$ , Park's Equations can be reduced to the following:

$$jV = jX_{ls} i_{ds} + jX_{md}(i_{md} + i_{kd} + i_{fd}) \quad (14)$$

$$V = jX_{ls} i_{qs} + jX_{mq}(i_{qs} + i_{kq}) \quad (15)$$

$$0 = jX_{kd} i_{kd} + jX_{md}(i_{ds} + i_{kd} + i_{fd}) \quad (16)$$

$$0 = jX_{fd} i_{fd} + jX_{md}(i_{ds} + i_{kd} + i_{fd}) \quad (17)$$

$$0 = jX_{kq} i_{kq} + jX_{mq}(i_{qs} + i_{kq}) \quad (18)$$

The above equations can be used to construct the equivalent circuit of the salient pole synchronous machine shown in Fig. 1. In this figure the operational impedances  $X_{ds}(js)$  and  $X_{qs}(js)$  correspond to the thevenin impedances looking into the circuit from the dashed line. The asynchronous electromagnetic torque can be calculated from the instantaneous power transfer across the air gap in much the same manner as for an induction machine [9,10]. Assuming zero stator resistance, the pulsating torque amplitude  $T_{puls}$  as a function of the slip is given as [9]:

$$T_{puls} = 0.5 |i_{ds}| |i_{qs}| |X_{ds}(js) - X_{qs}(js)| \quad (19)$$

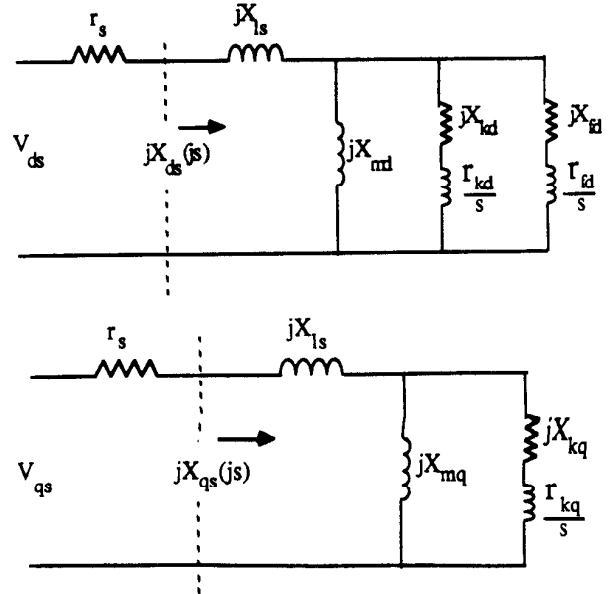

Fig. 1 Steady-State Constant Speed Equivalent Circuit of Salient Pole Synchronous Machine During Asynchronous Operation.

The average torque  $T_{ave}$ , as a function of the slip is given as:

$$T_{ave} = 0.5 \text{ Real} [ i_{ds} X_{ds}(js) i_{qs}^* - i_{qs} X_{qs}(js) i_{ds}^* ] \quad (20)$$

where the asterisk denotes the complex conjugate of the quantity.

### COMPARISON OF APPROXIMATE TORQUE EQUATION WITH EXACT SIMULATION

In order to determine the accuracy of the approximate torque expression, the starting electromagnetic torques of a medium size 25 hp salient pole synchronous motor have been calculated using both the full order simulation model and the approximate algebraic expression, Eqs. (19) and (20). The measured parameters of the machine are shown in the Appendix.

Figure 2 shows the starting instantaneous torque calculated using the full order simulation model and envelope of peak torques obtained from the approximate model for the case of a shorted field circuit. The approximate method calculates the average and pulsating torque component as a function of the slip frequency from which the lower and upper bound of the electromagnetic torques are found. Comparing the results of the full and approximate models, apart from the difference due to the initial transient torque, the approximate method gives peak values of the instantaneous torque that compare well with the full order model. Similar correlation was obtained with the other values of discharge resistances.

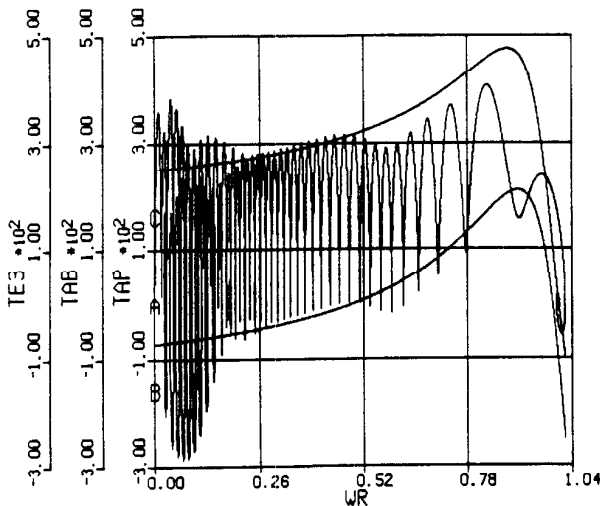

Fig. 2 Simulation Result Showing Electromagnetic Torque in Nt.M. vs. Per Unit Speed for Full Voltage Start with Shorted Field. Smooth Lines Denote Maximum and Minimum Values of Torque Computed with Eqs. 19 and 20.

### COMPARISON OF METHODS FOR MEASURING ELECTROMAGNETIC AIRGAP TORQUE OF SYNCHRONOUS MACHINES

In general, numerous methods can be used to measure electromagnetic torques depending on whether the steady state average or instantaneous torques are desired. For the steady state average torques, the demand on the speed of response of the measuring system is far less exacting than for instantaneous torques. In synchronous machines where the torques can vary with a frequency of once or twice the supply frequency, the average torque in most cases can be measured by mechanical means while the measurement of the instantaneous values must of necessity be done with non-mechanical methods. Test methods used for the measurement of electromagnetic torques can therefore be divided into two categories; mechanical and electrical methods [3].

### MECHANICAL METHODS FOR MEASUREMENT OF ELECTROMAGNETIC TORQUE TRANSIENTS

Examination of the mechanical equation of motion of synchronous machines provides a clue to the measurement of the electromagnetic torque. If the load is set to zero and the friction

torque neglected Eq. (6) can be expressed in the form

$$T_e \approx J p \omega_{rm} \quad (21)$$

where  $\omega_{rm}$  is the mechanical speed in radians per second and is equal to  $2\omega_p/P$ . Hence, in cases where the load and frictional torque are known or assumed negligible, the electromagnetic torque can be readily derived from the measurement of acceleration. In addition to the instantaneous value of the acceleration, determination of the instantaneous electromagnetic torque requires knowledge of the inertia of the shaft and connected load as well as friction torque and load torques. When the frequencies of the acceleration and load torque and the absolute values of the acceleration are not too large, the measurement can be carried out with commercially available equipments for measuring acceleration and load torque with precaution taken to exclude the interfering influence of the mechanical vibrations.

A key to the mechanical method of measuring starting torque therefore entails the measurement of the acceleration of the motor shaft (together with the load torque, which is normally set to zero). Mechanical measurement of acceleration is usually accomplished by using piezoelectric accelerometers [1,11]. The piezoelectric accelerometer has two important limitations: transverse sensitivity and poor low frequency response. Transverse sensitivity corresponds to the problem of accelerometer response to acceleration components normal to the axis of rotation. Although typical manufacturer specifications for transverse sensitivity range from less than five percent, improper mounting geometry can significantly increase this effect. In addition, the lower limit of frequency response for piezoelectric accelerometers is typically several hertz and requires extreme care and skill when using them for direct measurement of the average torque component.

In Fig. 3 is shown the measured starting electromagnetic torque obtained with the aid of an accelerometer manufactured by Hoodwin Instruments. While the average torque obtained by the accelerometer is reproduced reasonably accurately, the pulsating torques are attenuated severely. This is due to the fact that the accelerometer is not able to pick up the high frequency component of the pulsating torques.

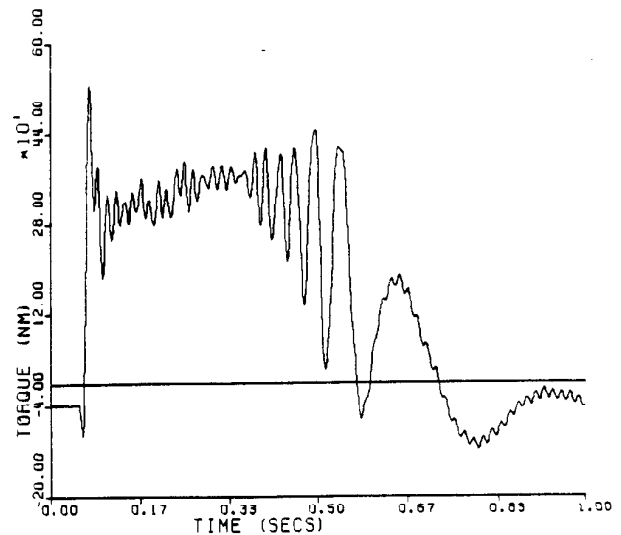

Fig. 3 Measured Result Showing Electromagnetic Torque vs. Time for Full Voltage Start with Shorted Field Using Accelerometer Technique.

### MEASUREMENT OF ELECTROMAGNETIC TORQUE USING SEARCH COILS AND CURRENT SENSORS

There are basically four electrical methods for measuring the electromagnetic torque of alternating current electrical machines. The first is a "direct" measurement of air gap flux and stator current which in essence forms the components of the electromagnetic torque, see Eq. (8). The measurement of flux involves the use of Hall probes or search coils in the air gap of the machine. The use of Hall probes at the air gap of electric machines unfortunately has

severe practical limitations. There is the possibility that these probes can be damaged during installation in the air gap or in the course of measurement. Since the probes are placed directly on the armature winding, which in general is one of the hottest portions of the machine, their performance can be degraded as the temperature of the windings increases. In view of these limitations, this method for the measurement of electromagnetic torques is not attractive.

Search coils together with current sensors represent the most inherently accurate method for measuring electromagnetic torque. These coils are made of very thin wires, typically teflon coated copper or special piano wire, which are placed around slots of the stator of the machine. The voltage induced in these coils is sensed and integrated to produce a measure of air gap flux linkage. These flux coils require extra operations for installing the armature winding of the machine and therefore increase the manufacturing cost. Also, since the coils are made of very thin wires they are subjected to breakage due to vibration or continual flexing and therefore require skillful handling. Kamerbeek [2] has shown rather rigorously that if hysteresis is neglected, and if the magnetic field can be considered as a state function, the electromagnetic torque acting on the shaft can be expressed as the following integral equation

$$T_e = r \int B_r H_\phi dA \quad (22)$$

In the above equation,  $B_r$  is the radial component of the air gap magnetic flux density and  $H_\phi$  is the tangential component of the magnetic field intensity.  $A$  and  $r$  are the area and radius of the cylindrical surface containing the air gap. The above equation also assumes that the flux penetrating the ends of the machine is zero. In terms of induced voltages in the search coils for an ungrounded machine, Eq. (22) results in [3]:

$$T_e = \frac{\sqrt{3}P}{2} K_w [i_c \int v_{mb} dt - i_b \int v_{mc} dt] \quad (23)$$

In Eq. (23),  $K_w$  is the fundamental number of effective turns of the armature winding divided by the fundamental number of turns of the search coil winding. The voltages  $v_{mb}$  and  $v_{mc}$  correspond to the induced voltages in a pair of search coils located concentric with the magnetic axes of the b and c phases of the machine windings while  $i_b$  and  $i_c$  are the currents in phases b and c respectively. A sample of the induced search coil voltage and the phase voltage of phase C are shown in Fig. 4 where they are shown to be in-phase. This method can be termed an air gap flux-ampere method (AGFA). Figure 5 shows the electromagnetic torque measured by using the direct search coil method (AGFA method). Good correlation with the ideal simulation traces, Fig. 2, is apparent. One important difference is the small 120 Hz ripple component which occurs when the rotor approaches synchronous speed. It was determined, however, that this component is a measurement error caused by the analog multipliers used for the torque calculation. Since this method inherently accounts for effects which were neglected in the solution of Park's Equations, for example saturation, iron losses, deep bar effect, windage and friction, etc, this trace can be used as a basis for comparison of other, more approximate measurement methods.

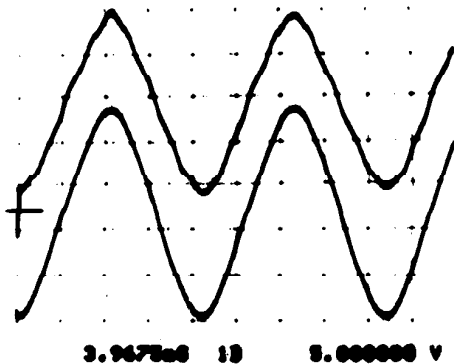

Fig. 4 Induced Voltage in Search Coil #01 (Upper Trace) and in Stator Phase c. Conditions: Stator Open Circuited, Rated Speed, Field Current  $I_{fd} = 1.45$  Amperes.

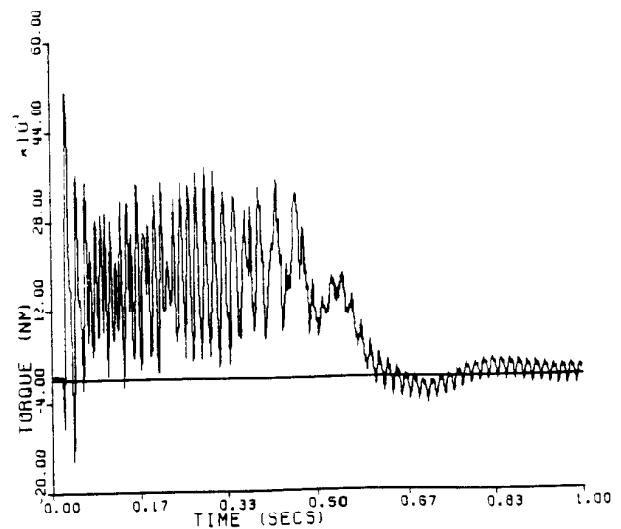

Fig. 5 Electromagnetic Torque vs. Time for Full Voltage Start with Shorted Field Using Stator Current and Flux Coil Measurement, Eq. 23.

### MEASUREMENT OF ELECTROMAGNETIC TORQUE USING INPUT POWER AND SPEED SENSING

The equations relating the input electrical power and the mechanical power output can be derived from the Park's equations. If Park's stator and rotor equations for the d and q axes are multiplied by their respective axis currents, an expression for the instantaneous power input is obtained.

$$P_{in} = 1.5 [v_{ds} i_{ds} + v_{qs} i_{qs}] + v_{fd} i_{fd} \quad (24)$$

When the equations for the voltages, Eqs. 1-5, are substituted in Eq. (24), the input power can be written as

$$P_{in} = P_{loss} + P_{mag} + P_{mech} \quad (25)$$

where,  $P_{loss}$  is the instantaneous ohmic copper losses,  $P_{mag}$  is the instantaneous time rate of change of magnetic field energy stored in the magnetic field and  $P_{mech}$  is the portion of the input power which is converted into mechanical power. The equations for the various energy components are given as follows

$$P_{loss} = 1.5 r_s [i_{ds}^2 + i_{qs}^2] \quad (26)$$

$$P_{mag} = 1.5 [i_{ds} \frac{P}{\omega_b} \psi_{ds} + i_{qs} \frac{P}{\omega_b} \psi_{qs}] \quad (27)$$

$$P_{mech} = 1.5 \left( \frac{\omega_r}{\omega_b} \right) [i_{qs} \psi_{ds} - i_{ds} \psi_{qs}] \quad (28)$$

Since the mechanical power is clearly a rotational power component it can be represented as the product of the torque and the rotational speed. Examination of Eq. (25) indicates that the instantaneous electromagnetic air gap torque can be calculated by subtracting the ohmic losses of the stator windings and the time rate of change of magnetic field energy from the stator input power, then dividing by the rotor speed. That is, without approximation

$$T_e = \left( \frac{P_{in} - P_{loss} - P_{mag}}{\omega_r} \right) \frac{P}{2} \quad (29)$$

During quasi-steady state operation, the time rate of change of magnetic field energy is nearly zero. If the stator losses are negligible the torque can be measured sufficiently accurately from an input power/speed measurement. It is important to note however, that during operation near half speed the magnetic field energy changes rapidly, resulting in considerable inaccuracy near this condition [4]. In general, the effect of stator resistance on the input power measurement can again be compensated. In this case the method can be termed a modified input power-speed method (MIPS) defined by Eq. 32.

$$T_e \equiv \frac{P_{in} - P_{loss}}{\omega_r} \frac{P}{2} \quad (30)$$

Figure 6 shows the results of the modified input power-speed method this time using a computer simulation. Note the very large torque pulsations during starting. In practice, these pulsations are caused by two effects. First, when the motor speed is at rest the torque equation as defined by Eq. (30) is indeterminate. Inaccuracies in the speed measurement are therefore greatly magnified. Secondly, the stored energy in the machine clearly changes rapidly at low speed since the machine is initially unexcited. When expressed as power by means of Eq. 27, and divided by small values of speed, the effect of this term on the torque equation is dominant. These errors combine to make the measurement of torque using Eq. (30) unacceptable.

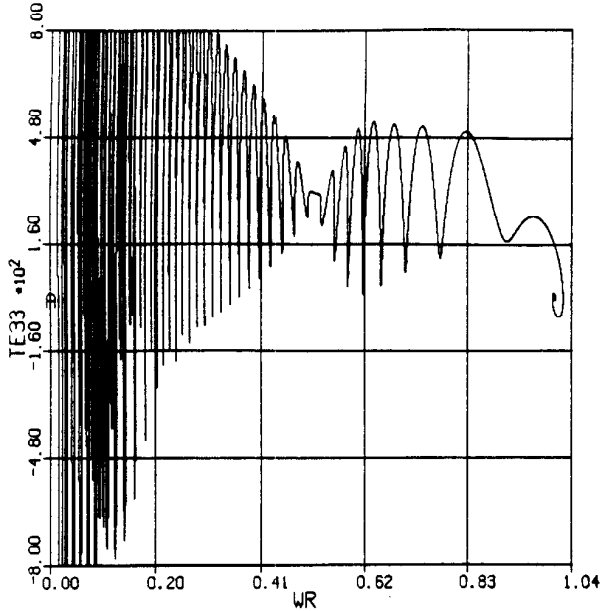

Fig. 6 Simulation Result Showing Electromagnetic Torque vs. Speed for Full Voltage Start with Shorted Field Utilizing Eq. 30.

#### MEASUREMENT OF ELECTROMAGNETIC TORQUE USING INPUT POWER SENSING

The concept of "synchronous watts", suggested in Ref. 4, provides another means for calculating electromagnetic torque. In particular, if the stator currents are balanced and sinusoidal, then phasor concepts can be used for analysis. The power transferred across the air gap is responsible for the the electromagnetic torque during acceleration in much the same manner as for an induction machine. However, while the approach is valid for induction machines it is not strictly correct for unsymmetrical machines. While approximate for the case of the synchronous machine, the torque can be expressed as

$$T_e \equiv \frac{P}{2} \frac{P_{ag}}{\omega_e} \quad (31)$$

where  $\omega_e$  is the angular frequency of the source and  $P_{ag}$  represents power at the air gap. If the stator magnetic stored energy is again assumed to not change rapidly, the torque can be estimated from

$$T_e \equiv \frac{P}{2} \frac{P_{in} - P_{loss}}{\omega_e} \quad (32)$$

where  $P_{loss}$  is the stator copper loss. This method is termed the modified input power method (MIP).

Figure 7 shows a torque versus time trace by the modified input power (MIP) method. Note that reasonably good results are obtained except for significant deviations at the regions near zero speed and around half speed where the magnetic stored energy changes rapidly.

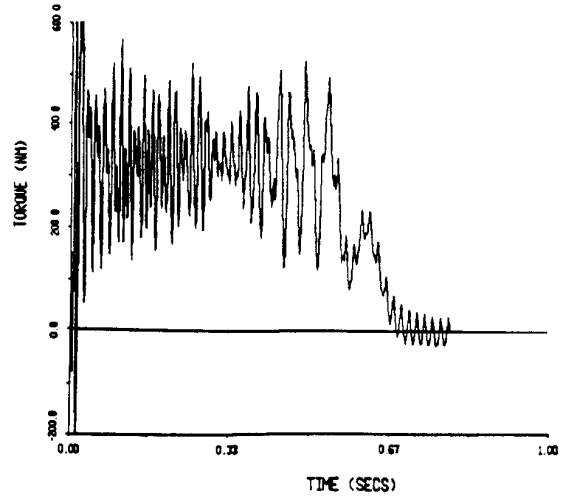

Fig. 7 Measured Plot of Electromagnetic Torque vs Time for Full Voltage Start with Shorted Field Using Input Power Measurement, Eq. 32 (MIP Method).

#### MEASUREMENT OF ELECTROMAGNETIC TORQUE USING TERMINAL VOLTAGE AND CURRENT SENSING

If the magnetic hysteresis, eddy currents, skin effect stator resistance and armature tooth saturation are neglected, starting from Eq. 7 it can be shown that the electromagnetic torque of a synchronous machine can be expressed as a function of the terminal voltage and current by

$$T_e \equiv \frac{\sqrt{3} P}{6} [(i_a - i_b) \int v_{ca} dt - (i_c - i_a) \int v_{ab} dt] \quad (33)$$

Hence, the torque can be computed using only two line-to-line voltages and two current measurements. It should be noted that the current transducers should be capable of sensing dc currents since during acceleration the negative sequence currents on the rotor produce a variable frequency component which passes through zero at half speed.

When stator resistance is appreciable Eq. (24) can be modified to the form

$$T_e = \frac{\sqrt{3} P}{6} \left\{ (i_a - i_b) \int [v_{ca} - r_s(i_c - i_a)] dt - (i_c - i_a) \int [v_{ab} - r_s(i_a - i_b)] dt \right\} \quad (34)$$

Note that if the  $iR$  compensation is accomplished precisely this expression for electromagnetic torque is "exact". That is, it yields the same results as Eq. 7.

Since the stator resistance changes with temperature and is only approximately known, care must be taken in interpreting the results. For purposes of identification, this technique is termed the modified volt-second ampere method (MVSA). Figure 8 shows the measurement result using the MVSA method, Eq. 34. Note the marked similarity to the method using search coils, Fig. 5. Again, the 120 Hz ripple component as the machine reaches synchronous speed can be attributed to measurement error. For comparison purposes, Fig. 9 shows the same measurement, this time not compensating for stator resistance (Eq. 24). In this case the measurement method can be termed the volt-second ampere (VSA) method. A substantial difference from Fig. 5 is now apparent. In particular, the pulsating torque components at low speed are substantially increased suggesting that the stator voltage drop across the stator resistance is significant during starting for this machine. Hence, unless the machine is very large, neglecting the effects of stator resistance can cause appreciable errors in the torque measurement.

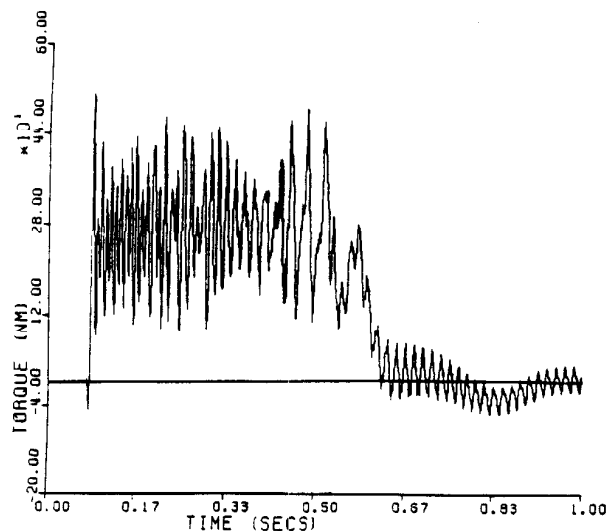

Fig. 8 Measured Trace of Electromagnetic Torque vs Time for Full Voltage Start with Shorted Field Using Stator Current and the Modified Integral of the Line-to-Line Voltage, Eq. 34 (MVSA Method).

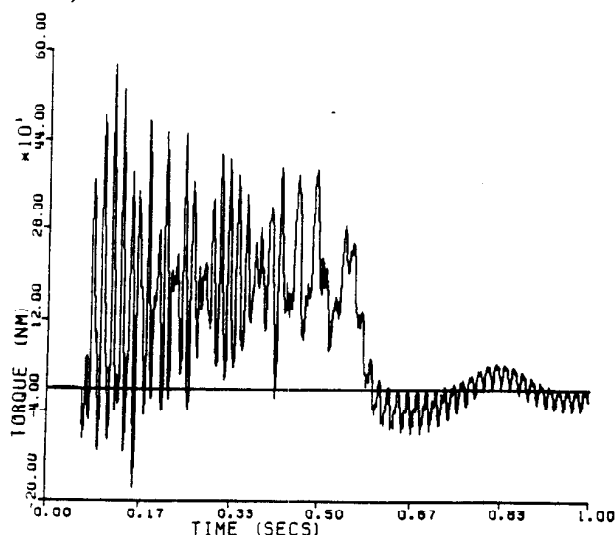

Fig. 9 Measured Trace of Electromagnetic Torque vs Time for Full Voltage Start with Shorted Field Using Stator Current and the Integral of the Line-to-Line Voltage, Eq. 33 (VSA Method).

### CONCLUSIONS

Five methods for the measurement of instantaneous electromagnetic torque of salient pole synchronous motors during starting have been investigated and implemented on a medium size 25 hp machine. Results from these tests are compared to those obtained from a full and an approximate model of the machine. It was shown that for the computation of peak electromagnetic starting torque or its pulsating component, the approximate quasi-linear model gives good engineering results. This model can be used with confidence for the design optimization of the damper windings to reduce the pulsating starting torque of the machine. It was also shown that the search coil method gives the best result followed by a new modified volt-second ampere (MVSA) measurement method which utilizes only two line-to-line voltages and two line currents. The other two commonly used electrical methods give results that are only roughly comparable to that computed from the full order model. Due to the inability of the accelerometer to respond to the high frequency component of the electromagnetic torque, the accelerometer method gives results which are accurate only for measuring average components of accelerating torque.

In conclusion, the modified input volt-second ampere (MVSA) method is suggested for the measurement of the

electromagnetic torque of salient pole synchronous machine because of its simplicity of implementation. While the search coil approach gives the best results, special manufacturing considerations will be required to install the search coils with the possible attendant increase in cost probably preventing practical widespread application in the near future.

### ACKNOWLEDGMENTS

This work was sponsored by the Electric Power Research Institute under contract number RP2308-12. The authors are indebted to the Wisconsin Electric Machines and Power Electronics Consortium for equipment provided.

### REFERENCES

- [1] E. M. H. Kamerbeek, "Torque Measurements on Induction Motors Using Hall Generators or Measuring Windings", Philips Tech. Rev., Vol. 34, No. 7, October 1974, pp 153 - 162.
- [2] E. M. H. Kamerbeek, "On the Theoretical and Experimental Determination of the Electromagnetic Torque in Electrical Machines", Philips Tech. Rev. Supplement, No. 4, 1970.
- [3] T. Holt, "Measurement of Electromagnetic Air Gap Torque Produced by a Synchronous Motor During Starting", IEEE Trans. on Power Apparatus and Systems, Vol. PAS -100, No. 4, April 1981, pp. 2059 - 2066.
- [4] C. B. Mayer and E. L. Owen, Discussion of Ref. 3 above, IEEE Trans. on Power Apparatus and Systems, Vol. PAS -100, No. 4, April 1981, pp. 2066 - 2067.
- [5] T. A. Lipo and K. C. Chang, "A New Approach to Flux and Torque Sensing in Induction Machines", IEEE Trans. on Industry Applications, Vol. IA - 22, No. 4, pp. 731 - 736, July/August 1986.
- [6] T. A. Lipo and M. E. Kramer, "Measurement of Induction Motor Torque Pulsations Due to Inverter Supply", in Vibrations and Audible Noise in Alternating Current Machines (Book), Kluwer Academic Publishers, pp. 191-211, 1988.
- [7] T.A. Lipo and J.O. Ojo, "Evaluation of Measurement Techniques for Evaluating Torque Pulsations During Starting of Synchronous Machines", E.P.R.I. Final Report. Contract No. RP2308-12.
- [8] P. C. Krause, Analysis of Electric Machinery, (Book), McGraw-Hill Publisher, New York, 1986.
- [9] E. L. Owen, H. D. Snively and T. A. Lipo, "Torsional Coordination of High Speed Synchronous Motors - Part II", IEEE Trans. on Industry Application, Vol. IA - 17, No. 6, Nov/ Dec 1981, pp. 572 - 580.
- [10] J. Bredthauer, B. Wachta and S. Appleton, "Synchronous Motors With Cylindrical Rotors for the Petroleum Industry", IEEE Trans. on Industry Application, Vol. IA - 23, No. 3, May/ June 1987, pp. 451 - 463.
- [11] G. Mruk, J. Halloran and R. Kolodziej, "Torsional Response of Compressor Shaft Systems During Synchronous Motor Start up" ASME Publication 77-Pet-49, Energy Technology Conference and Exhibit, Sept. 18-22, 1977.

### APPENDIX

The tested 6 pole salient pole synchronous motor is rated 25 hp, 208 volts line to line, 57.8 amperes rated current. The ratings of the field circuits are 125 volts and 3.8 amperes for unity power factor operation. The measured parameters for the simulation of motor starting performance are as follows:

- Stator resistance,  $r_s = 0.0667$  ohm
- Stator leakage reactance,  $X_{ls} = 0.1212$  ohm.
- D - axis magnetizing reactance,  $X_{md} = 2.42$  ohms.
- Q - axis magnetizing reactance,  $X_{mq} = 1.483$  ohms.
- Field leakage reactance,  $X_{fd} = 0.6291$  ohm.
- D - axis damper winding leakage reactance,  $X_{kd} = 0.574$  ohm.
- Q - axis damper winding leakage reactance,  $X_{kq} = 0.594$  ohm.
- Moment of inertia of the unloaded motor,  $J = 0.80$  kg - m<sup>2</sup>.