

# MCTS AND IGBTs: A COMPARISON OF PERFORMANCE IN POWER ELECTRONIC CIRCUITS

S.K. Sul, F. Profumo, G.H. Cho and T.A. Lipo  
University of Wisconsin  
Department of Electrical and Computer Engineering  
1415 Johnson Drive  
Madison, WI 53706 U.S.A.

**ABSTRACT** There is a continuous demand to improve the quality of switching power devices such as higher switching frequency, higher withstand voltage capability, larger current handling capability, and lower conduction losses. However, for single conduction mechanism devices (SCRs, GTOs, BJTs, FETs) to possess all these features desired is, for physical reasons, probably unrealizable. An attractive solution appears to be double mechanism devices in which the features of both a minority carrier device (BJTs or SCRs) and a majority carrier device (MOSFETs) are embedded. Both IGBTs (Insulated Gate Bipolar Transistors) and MCTs (MOS Controlled Thyristors) belong to this family of double mechanism devices and promise to have a major impact on new converter circuit designs. This paper deals with the major features of these two new devices, pointing out those that are most critical to the design of new converter topologies. In particular, the two devices have been tested in a both a chopper and in two resonant link converter topologies and the experimental results are reported.

## INTRODUCTION

The technology of AC/DC power conversion has largely been stabilized ever since the introduction of SCRs in the 50's since from an industrial point of view, the power solid-state devices, converter circuit topology, and control techniques have been virtually fixed since that time. On the other hand, the technology for DC/AC converters and even more so for direct AC/AC conversion is, after more than twenty years of research, still in the development stage. The choice of the power solid-state device, the converter circuit topology and control techniques are related to the application and to the power range. However, high efficiency, high reliability, low noise, compactness and light weight continue to be general requirements for almost every field of application: inverters for industry, appliances and robotics, as well as uninterruptible power supplies for computers and medical equipment.

At the present time, digital controllers for AC drives are realized by means of the available tools on the market. Digital Signal Processors (DSPs) or 32-bit general purpose microprocessors are quite powerful in term of speed and accuracy of calculation. On line calculations such as those required for current control or for accurate calculation of torque can be done within the inherently strict time constraints.

On the other hand, most of the performance deficiencies in actual converter topologies are related to the non-ideal behavior of the power solid-state devices. Looking back fifteen years, PWM techniques were studied primarily on paper. In fact, because the maximum switching frequencies of early SCRs (the only power devices available at that time) were so far from that of an ideal device that output waveforms contained significant higher order harmonics to the point where the predicted and actual waveforms rarely matched. This real world complication demonstrates the tight relationship which exists between the converter circuit topology and the power solid-state device being used.

There is a continuous demand on power solid-state device manufacturers by converter manufacturers to improve the quality of switching power devices. Experience in the last twenty years has taught us that new developments in device characteristics always bring corresponding improvements in converter circuit technology. Some of the device improvements especially important are higher switching frequency, higher withstand voltage capability, larger current handling capability, and lower conduction losses. However, for single mechanism devices (SCRs, GTOs, BJTs, FETs) to possess all these desired features is, for physical reasons, probably unrealizable.

An attractive alternative solution appears to be double mechanism devices, in other words, composite devices with the features of both a BJT or SCR and a MOSFET. These new devices should ideally be MOS gated, able to handle high withstand voltages and carry large currents that can be switched up to several tens of kHz. Both IGBTs (Insulated Gate Bipolar Transistors) and MCTs (MOS Controlled Thyristors) belong to this family of double carrier devices and promise to have a major impact on new converter circuit designs. In terms of performance, the IGBT is preferred over other present devices because of lower gating power requirements and higher switching speed. For power levels greater than that achievable with IGBTs, the MCT is intended to replace the currently used power devices (SCRs and GTOs).

This paper compares the major features of these two new devices, pointing out those features that are most critical to design of new converter topologies. In particular, the two double carrier devices have been tested in a hard switching chopper circuit and a

soft switched resonant link converter topology and the experimental results are reported.

### STRUCTURE AND OPERATION OF IGBTs AND MCTs

An ideal solid-state device for a power switching application should have the following major characteristics:

- gate turn-on and turn-off capability.
- low forward voltage drop (to keep conduction losses small).
- short turn-on and turn-off times (to keep switching losses small).
- high current density (to minimize component size and cost).
- low power gate circuit.

The characteristics of traditional single carrier devices can be summarized as follows:

- SCRs: no gate turn-off capability, high forward current density.
- BJTs: gate turn-on and turn-off capability, reasonably high switching frequency, but high base drive current during forward conduction and reverse base drive current for turn-off is required.
- GTOs: high forward current density, but low switching frequency and very high gate current required for turn-off.
- FETs: low forward current density, high switching frequency, and low power gate drive circuit.

In summary it is apparent that all common single carrier power devices do not match the requirements of an ideal switch.

### Insulated Gate Bipolar Transistor

The basic structure of an IGBT is quite similar to a MOSFET: in both cases the device consists of many individual cells connected in parallel. The main difference between the two components is an additional p+ layer in the collector side of an IGBT and an additional NP junction. The steady state equivalent circuits derived for both the devices are depicted in Fig.1. The IGBT in the steady state can be modeled as a bipolar PNP transistor driven by an n-channel MOSFET. This PNP transistor has an unusual structure because its base width is relatively large and modulated by the collector-emitter voltage. The additional parasitic NPN transistor is also shown. The IGBT is a controlled turn-on and turn-off device and its gate presents a capacitive load to the gate drive circuit, similar to a MOSFET [1-5].

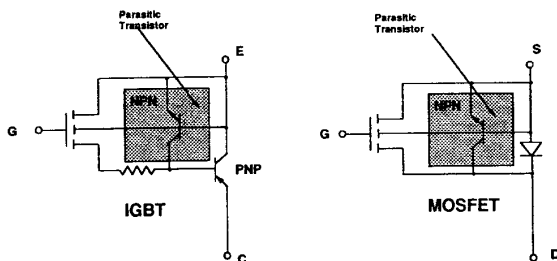

Fig.1: IGBT and FET Unit Cell Equivalent Circuits.

The IGBT's main features are:

- gate turn-on and turn-off capability.
- forward voltage drop in the same range as a BJT.
- turn-on and turn-off times slightly longer than a MOSFET.
- current density greater than a BJT.
- low power gate drive requirements similar to a MOSFET.

### MOS Controlled Thyristor

The MCT tested is a complementary type device and the unit cell equivalent circuit is shown in Fig. 2 which is somewhat different than shown in Ref. 6. There are several ways to turn-on the device [7]. The most useful method is to use the built-in "on-FET" which is effectively connected between the emitter and collector of the upper transistor. The same gate terminal can be used for turn-on and turn-off by applying a negative or positive voltage. The gate voltage should be applied between gate and anode of the device. To turn-off the device, the off-FET realizes an active short circuit between the emitter and the base of the upper transistor and has to be turned on. Thereby, the entire current is diverted to the off-FET and bypasses the p-n junction of the upper transistor. Thus the turn-off process has to:

- break the latched condition
- recombine the excess carriers in the two base layers.

The MCT main features are:

- gate turn-on and turn-off capability.
- forward voltage drop in the same range as a thyristor.
- turn-on and turn-off times equal or shorter than a GTO.
- current density much greater than a BJT.
- low power gate drive requirements similar to a MOSFET.

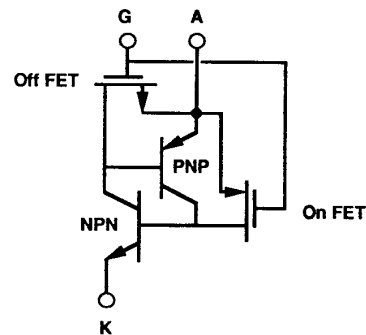

Fig.2: Schematic Circuit of Typical MCT Unit Cell.

### IGBT AND MCT GATING CIRCUIT FEATURES

IGBTs and MCTs are both voltage driven devices and the input characteristics are similar to power MOSFETs. As a consequence, the gating circuits, at least in principle, should be both simple and not differ significantly from MOSFET drivers. The IGBTs have a gate-to-emitter threshold voltage  $V_{ge(th)}$  and a capacitive input impedance (a few thousand pF). The mechanism to turn-on the device is to charge up the input capacitance to a value greater than  $V_{ge(th)}$ . The recommended gate voltages are

on the order of  $\pm 15$  V. The turn off mechanism requires a resistor  $R_g$  on the gate path in order to permit the gate-to-emitter input capacitance to be discharged.

IGBTs are very high gain devices and they can "latch-up" if the maximum controllable current is exceeded. The latching mode of operation has to be avoided since gate control is lost. If the device latches, it can not be turned off and it becomes a force commutated device similar to a thyristor. As a consequence, the drive circuit has to provide the facility to avoid the latching mode. Since the collector current amplitude depends on the  $V_{ge}$  value, a limit on the  $V_{ge(max)}$  avoids excessive collector current.

The drive circuit used for our study is shown in Fig. 3 where the "push-pull" stage provides the positive and negative pulses to "turn-on" and "turn-off" the device. In Fig. 4 the measured turn-on gating characteristics ( $V_{ge}$  and  $I_g$ ) are shown.

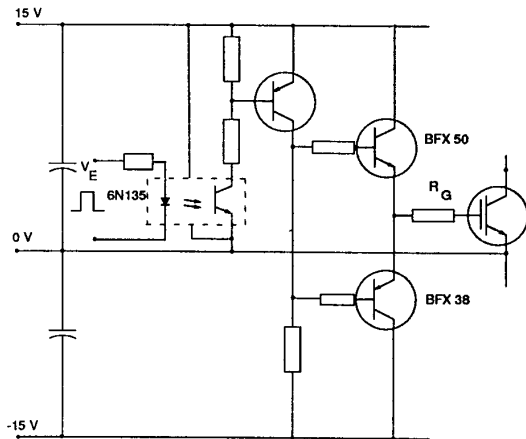

Fig. 3 IGBT Drive Circuit.

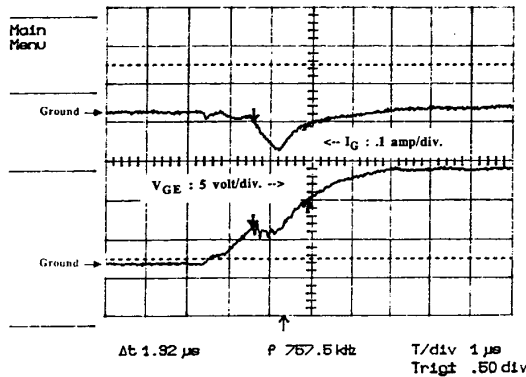

Fig. 4 Turn-On Gating Characteristics of IGBT.

The gating circuit to turn-on or turn-off the MCT, shown in Fig. 5, was designed specifically for the test. In the circuit an opto-isolator was again used to isolate the control and power circuits. Also, the power supply of the gating amplifier had a

different ground from the control power supply. To turn on (off) the MCT, negative (positive) voltage is applied between gate and anode. The voltage and current waveform of the gating circuit is shown in Fig. 6. It can be noted that the current is almost a spike which has a peak value around 2.5 Amp and a duration of 250 nsec. To turn on, 7 volts is applied to the gate and in the case of turn-off, negative 12 volts. In Figs. 7 and 8, the fall time and the rise time of the gate voltage is measured to be about 300 nsec.

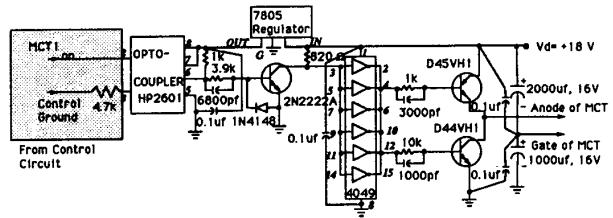

Fig. 5 MCT Gating Circuit.

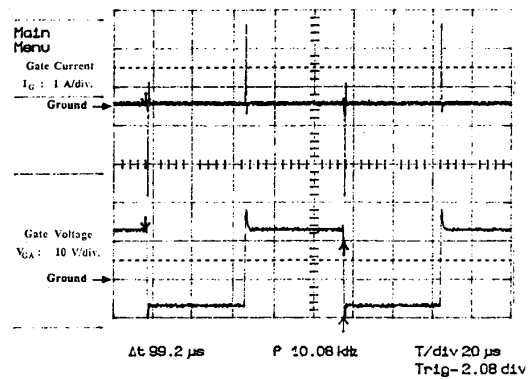

Fig. 6 Turn-On Gating Voltage and Current of MCT.

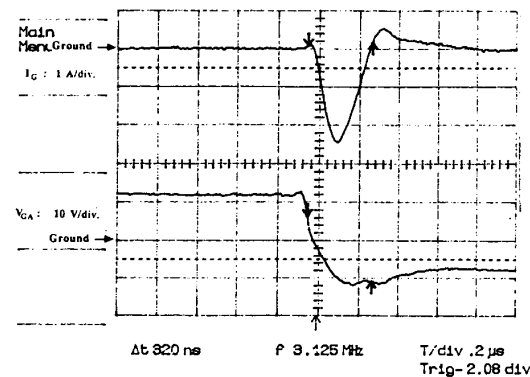

Fig. 7 Gating Characteristics of MCT at Turn-On.

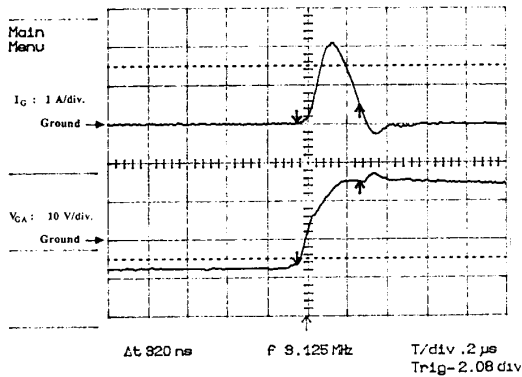

Fig. 8 Gating Characteristics of MCT at Turn-Off.

### TEST PROCEDURE

In order to evaluate the most significant device characteristics in terms of the converter design, several test circuits have been built for both the IGBT and MCT. The IGBT tested is a Toshiba device type MG25N2YS1, rated at 1200 Volt and 25 Amp. The MCT used for the test is a prototype device rated at 1400 Volts and 60 Amps manufactured by General Electric. Both devices have not been tested to their full rated voltage and current because of the limitation of the test facility and for practical considerations since only several MCTs were available for the test.

### Chopper Circuit

In order to test hard switching capability a simple chopper circuit was built and the two devices were tested in this mode. The selected switching frequency was 10 KHz and the DC bus voltage was set at 160 V. The chopper circuit employed is shown in Fig.9. Using this circuit, the basic switching and gating characteristics were investigated.

The overall operation of the chopper circuit is clearly shown in Fig. 10 where the switching frequency is 10 kHz. Because of the inductance of the load, the current increases exponentially for

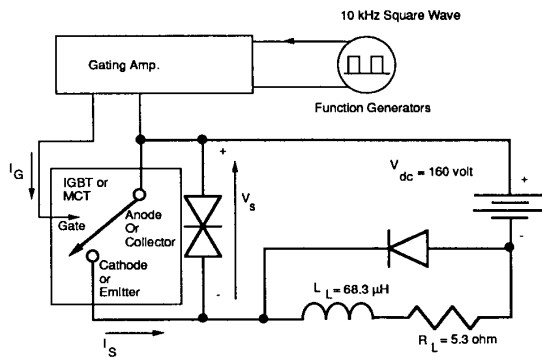

Fig.9: Chopper Circuit Used for the Device Test.

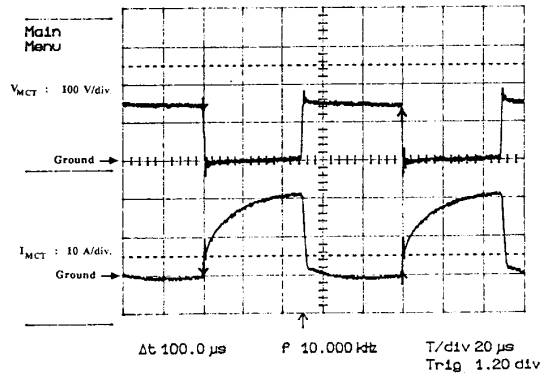

Fig. 10 Waveform Illustrating Overall Operation of Chopper Circuit.

the on-time of the MCT. A magnified view of Fig. 10 is shown in Fig. 11. From this figure it can be seen that the rise time of the MCT is about 360 nsec. From Fig. 12, which is the corresponding case of turn-off, the fall time is about 1.5 μs.

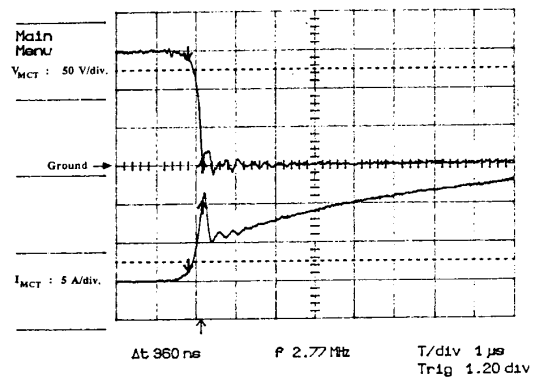

Fig. 11 Detailed View of Chopper Circuit of Fig. 10 Showing Turn-On of MCT.

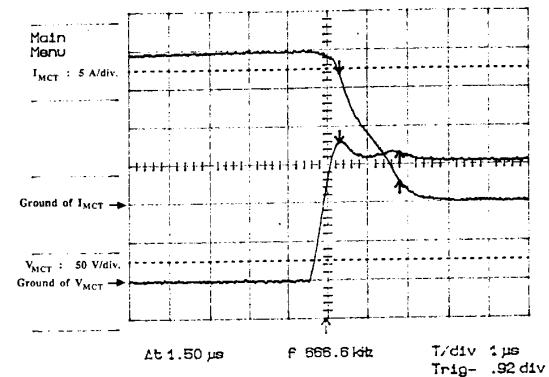

Fig. 12 Detailed View of Chopper Circuit of Fig. 10 Showing Turn-Off of MCT.

Delay time at turn-on and turn-off is shown in Figs. 13 and 14 respectively. From the figures it can be observed that the delay time during turn-on is 720 nsec. and at turn-off is 520 nsec. The switching characteristics of the MCT compared to that of the IGBT is summarized in Table 1. Note that while the speed of the MCT is slightly slower than the IGBT it is still very fast compared to most BJT devices.

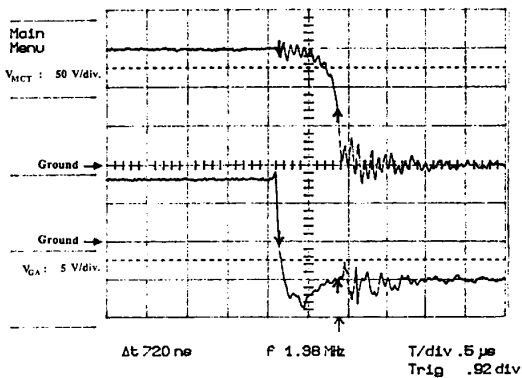

Fig. 13 Waveforms for Calculating Turn-On Delay of MCT.

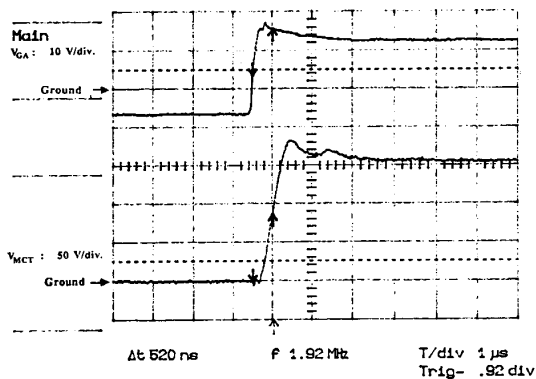

Fig. 14 Waveforms for Calculating Turn-Off Delay of MCT.

Parameters			IGBT	MCT
Gating	Current	on	100 mA	-2.2 A
		off	-240 mA	2.1 A
Signal	Voltage	on	0 → 15 V	12 V → -6 V
		off	15 V → 0	-6 V → 12 V
	Duration	on	1.2 μs	320 ns
		off	800 ns	320 ns
Switching Speed	Fall Time		900 ns	1.5 μs
			260 ns	360 ns
		On-Delay Time	670 ns	720 ns
		Off-Delay Time	470 ns	520 ns

Table 1: MCT and IGBT Gating and Switching Characteristics.

### Soft Switching Circuits

To investigate the switching characteristics under zero voltage and/or zero current, two different types of test circuits were built and used for testing. The first test circuit was the so called Parallel Output Series Resonant (POSR) converter [8], and the other circuit was a half bridge inverter with an inductor as a load.

The circuit schematic of the circuit used to test zero current switching is shown in Fig.15. Typical output voltage and device current waveforms are shown in Figs. 16 and 17. It apparent from these traces that MCTs and IGBTs have very comparable performance in such a circuit.

The inverter test circuit based on zero voltage switching used in the test is shown in Fig.18. Such circuits are becoming increasingly important, particularly in space power applications [9]. In many respects these two devices are ideal switching devices for such circuits. However, it is important to note that the output voltage and current waveforms, shown in Figs. 19 and 20, are substantially different for the MCT and the IGBT. The most significant difference between these traces is that the results for the MCT clearly show a glitch in every half cycle while the IGBTs does not. The effect is clearly forward voltage dependent and while the manufacturer specifies 5-6 volts, a much larger

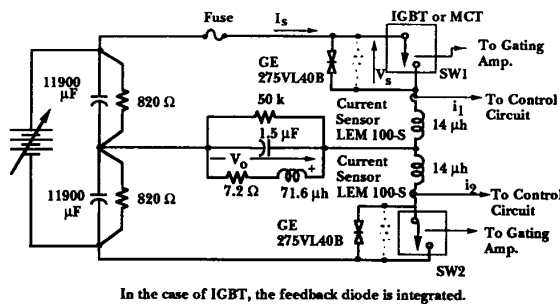

In the case of IGBT, the feedback diode is integrated.

Fig. 15 Parallel Output Series Resonant (POSR) Converter Configuration Used for the Test.

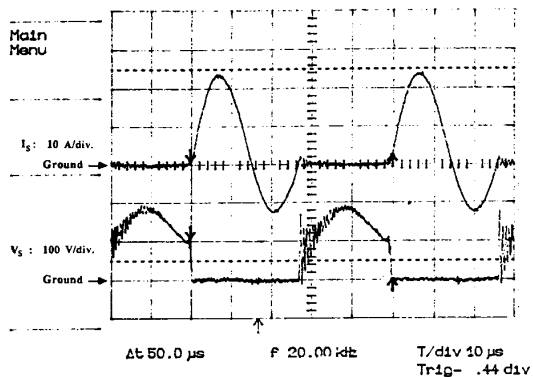

Fig 16 Output Voltage And Switch Current in POSR Converter Using IGBT.

**U-M-I**

The paper and ink used in the original material affect the quality of the scanned image. This reproduction is made from the best copy available.

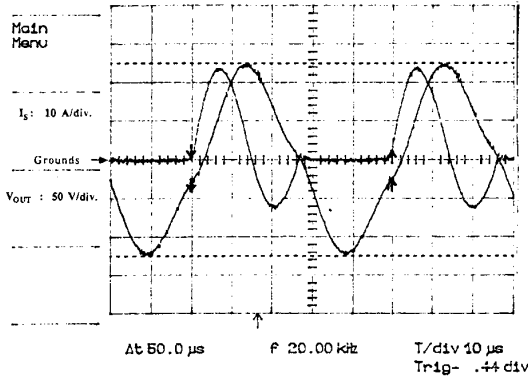

Fig 17 Output Voltage And Switch Current in POSR Converter Using MCT.

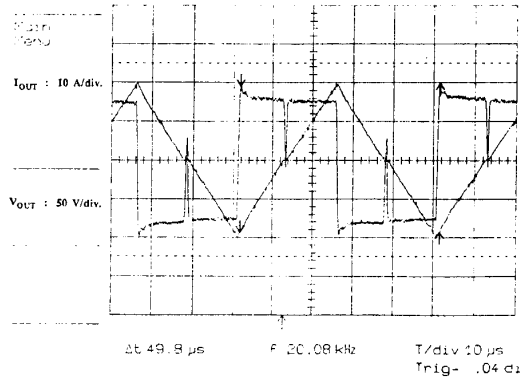

Fig. 20 Output characteristics of Zero Voltage Switching Circuit with MCTs. Note the Glitch Which Appears When the MCT Takes Over Current from the Diode.

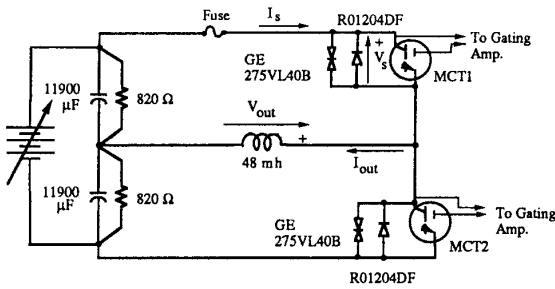

Fig. 18 Zero Voltage Switching Test Circuit.

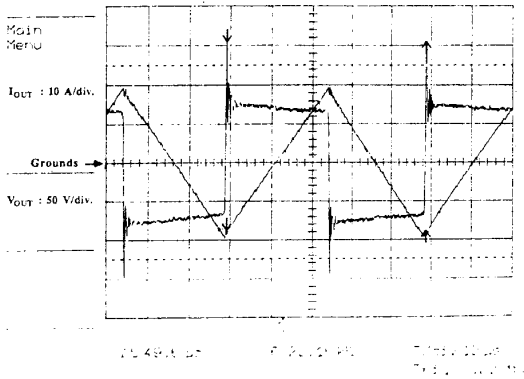

Fig. 19 Output Characteristics of Zero Voltage Switching Circuit with IGBTs.

"threshold voltage" was observed in this test. An expanded trace of the voltage across the MCT during current reversal through the MCT/diode switch is shown in Fig. 21. A peak voltage of about 90 Volts can be observed. While the peak forward voltage cannot be equated to the manufacturers threshold voltage,

difficulties during turn-on under such conditions are clearly apparent.

This difference in behavior can be explained by referring to the turn-on procedure of the two devices characterized by their equivalent circuits, see Figs. 1 and 2. It is apparent that the IGBT is not a latched device while the MCT is latched. Fundamentally the IGBT is similar to the bipolar darlington power transistor whose base drive transistor is replaced by a smaller MOSFET. Usually a slower switching speed is expected of the power darlington transistor due to the heavy saturation of the base drive transistor. In this regard it is not unexpected that the switching speed of the IGBT is faster than the power darlington because the drive device is a FET which is free from the carrier recovery problem. On the other hand, the MCT relies on its maximum current flow through PNP regenerative operation. Thus, the size of the On-FET need nominally be designed small enough to simply activate the PNP main current path.

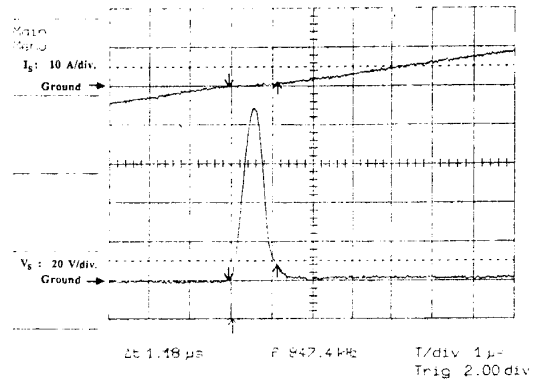

Fig. 21 Expanded Trace of Device Voltage and Current During Turn-On of MCT in Zero Voltage Switching Circuit.

If we compare the combination of the On-FET and NPN power transistor from the MCT equivalent circuit (Fig. 2) with that of the IGBT (Fig. 1), we can see that they are equivalent insofar as the initial current flow mechanism for turn-on. The difference, however, is that the On-FET current of the MCT has apparently been designed to be much smaller than that of the IGBT. This provides an explanation why the MCT requires a fairly high on-voltage across its anode and cathode terminal to reach PNP regenerative operation. The MCT is, of course, still under the development stage. It is anticipated that if the On-FET current magnitude of the MCT for triggering PNP operation can be increased to a larger value, the MCT could eventually become a suitable device for zero voltage switching.

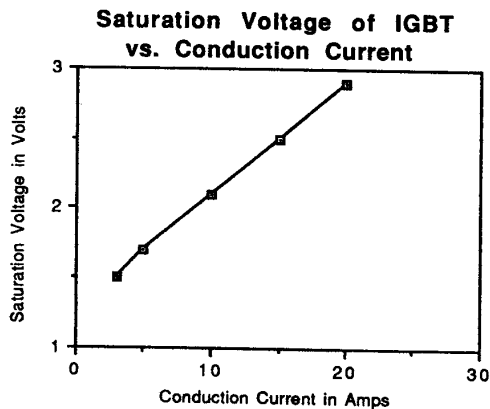

Fig. 22 Saturation Voltage of IGBT versus Conduction Current.

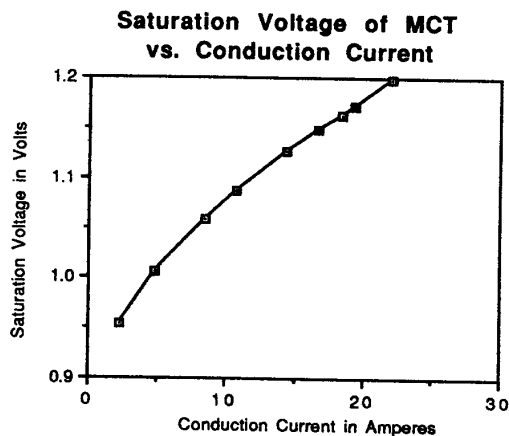

Fig. 23 Saturation Voltage of MCT Versus Conduction Current.

#### Saturation Voltage

As total device losses are key to device rating, the saturation voltage for DC conduction was also measured. The saturation voltage was measured with a calibrated Digital Voltmeter during DC conduction without any switching operation. The results are shown in Figs. 21 and 22 where the curve for the MCT demonstrates much less forward voltage drop in comparison to

the IGBT. The functional relationship of the saturation voltage vs. conduction current for the MCT is shown in Fig. 23. Note that the saturation voltage reaches only 1.2 Volts at 25 Amps.

#### CONCLUSION

In this paper two new power semiconductors are tested and compared in different circuit configurations. IGBTs are shown to be faster than MCTs, but they present more conduction losses due to higher forward voltage drop. On the other hand, the MCT's gate power requirements are greater than the IGBT's. The two devices have been shown to perform in a similar manner in both a hard switched chopper circuit and a soft switched resonant current link. Significant differences were detected, however, during turn-on in a soft switched resonant voltage link. A significant drawback to MCTs is the fact that they can not turn-on at zero voltage, at least with the present state of the art of the technology.

#### ACKNOWLEDGMENTS

The work reported in this paper was made possible by support from the industrial sponsors of the Wisconsin Electric Machines and Power Electronics Consortium (WEMPEC) and the NASA Lewis Research Center, Cleveland OH to whom the authors are greatly indebted.

#### REFERENCES

- [1] H. Yilmaz, "Cell Geometry Effect on IGT Latch-Up", *IEEE Electron Device Letters*, Vol. EDL-6, no. 8, pp. 419-421, August 1985.
- [2] B.J. Baliga, "Analysis of Insulated Gate Transistor Turn-Off Characteristics", *IEEE Electron Device Letters*, Vol. EDL-6, no. 2, pp. 74-77, February 1985.
- [3] B.J. Baliga, M. Chang, P. Shafer and M. Smith, "The Insulated Gate Transistor (IGT), A New Power Switching Device", *IEEE Industry Applications Society Annual Meeting*, October 1983.
- [4] H. Yilmaz, W.R. Van Dell, O. and M. Chang, "Insulated Gate Transistor Modeling and Optimization", *IEDM*, pp.274-277, 1984.
- [5] R. Bayerer and J. Telgelkötter, "IGBT-Diode Half-Bridge Modules Operate at 20 kHz", *PCIM*, pp. 21-27, December 1987.
- [6] B.J. Baliga, "Modern Power Devices", (book) Wiley-Interscience, New York, 1987, see pg. 402.
- [7] V.A.K. Temple, "MOS-Controlled Thyristors.- A New Class of Power Devices", *IEEE Trans. Electron Devices*, vol. ED-33, no. 10, pp. 1609-1618, October 1986.
- [8] N. Mapham, "An SCR Inverter with Good Regulation and Sine-wave Output", *IEEE Trans. Ind. Gen. Appl.*, Vol. IGA-3, pp. 176-187, Mar./Apr. 1967.
- [9] P. Sood, T.A. Lipo and I. Hansen, "A Versatile Power Converter for High Frequency Link Systems", *IEEE Trans. on Power Electronics*, vol. 3, No. 4, Oct. 1988, pp. 383-390.