

Wisconsin Electric Machines and Power Electronics Consortium

RESEARCH REPORT
93-22

New ZCS Resonant Power Converter Topologies for
Variable Reluctance Machine Drives

A. Hava, J.B. Wacknov, T.A. Lipo
Dept. of Electrical and Computer Engineering
University of Wisconsin-Madison
1415 Johnson Drive
Madison, WI 53706

WEMPEC

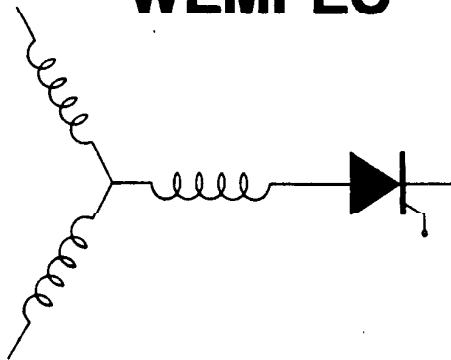

Department of Electrical and Computer Engineering
1415 Johnson Drive
Madison, Wisconsin 53706
© May 1993 Confidential

NEW ZCS RESONANT POWER CONVERTER TOPOLOGIES FOR VARIABLE RELUCTANCE MACHINE DRIVES

A. Hava

J.B. Wacknov

T.A. Lipo

University of Wisconsin-Madison
1415 Johnson Drive
Madison WI, 53706

Abstract-This paper describes new zero current switching converter topologies for variable reluctance machine drives. Zero current switching enables high frequency operation while maintaining low switching loss and reduced levels of electro-magnetic interference (EMI). This increase in frequency translates directly into improved current regulation in the machine phases, resulting in a high performance drive. The machine fundamentals are reviewed, converter topologies introduced, and simulation results of the total drive presented.

poles to align when excited by an MMF. Shown in Fig. 1, the simple machine geometry is designed in a manner such that the phase self inductance varies between a minimum (unaligned) and maximum (aligned) value as the shaft rotates. Torque is developed by injecting carefully programmed current pulses into the phases during the varying inductance interval.

1. INTRODUCTION

Intense research during the last decade has resulted in Variable Reluctance Machine (VRM) drives that are able to compete with more mature drive technologies. In addition to its relatively low cost, high torque/rotor volume ratio, and excellent controllability, it is primarily the machine's exceptionally robust and fault tolerant nature which has opened a market for the VRM. Successful applications of these drives have been reported from the fractional horsepower range to several hundred kilowatts. Operation of a VRM requires both a power converter and a shaft position sensor (or an observer). While adding to the expense of the drive, these constraints also limit the VRM market to applications where the requirement for a power converter is inevitable.

Power electronic converters commonly employed in VRM drives are based on hard switched topologies. In addition to significant levels of EMI and acoustic noise these circuits all suffer from high switching losses and are therefore limited in operating frequency. The torque developed by the machine is approximately proportional to the square of the current, and low frequency switching results in higher torque ripple. Therefore it can be advantageous to utilize Zero Current Switching (ZCS) principles and operate at higher switching frequencies so that current ripple, acoustic noise, and EMI can all be reduced. ZCS converters execute switching actions under a zero current condition forced by a resonant circuit; the resulting switching transient is very smooth and the device dissipation is minimal. Before these converter topologies are introduced it will be helpful to review the VRM fundamentals.

2. VARIABLE RELUCTANCE MACHINE REVIEW

The operating principle of the VRM, one of the earliest and simplest of all electric machines, is based on the 'minimum reluctance principle', i.e., the tendency of the stator and rotor

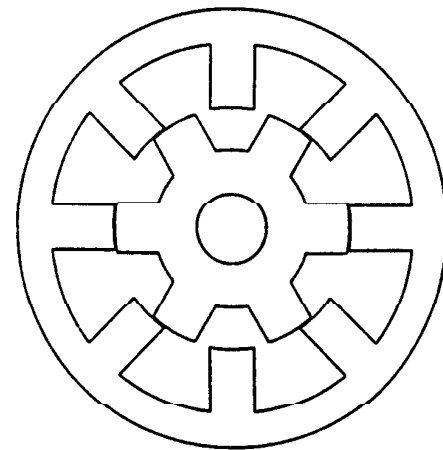

Fig. 1. Typical VRM with 8 stator and 6 rotor poles.

Regardless of the phase current polarity, motoring torque is produced during the increasing inductance interval and generating torque is developed during the decreasing inductance interval. Due to the highly nonlinear magnetic nature of the machine, the phase inductance is dependent both on the rotor position and the current. However, a linear inductance VRM model is adequate for exploring the behavior of the drive. Assuming no mutual coupling exists between the phases and no magnetic saturation occurs, the n th phase terminal voltage v_n can be expressed as follows.

$$v_n = r_n i_n + \frac{d(L_n i_n)}{dt} \quad (1)$$

where

r_n resistance of the n th phase;
 i_n instantaneous current in the n th phase;
 L_n instantaneous inductance of the n th phase.

$$\phi = \tan^{-1} \left[\frac{Z_0 I_0}{(k V_{dc} - V_{co})} \right] \quad (9)$$

Let us begin with the restriction that S1 can conduct current only in the direction indicated by the arrow in Fig. 3. Depending on the excitation provided by the source, (the value of k) the circuit can assume four different operating modes. Due to the sinusoidal nature of the resulting wave forms, if the capacitor voltage initial value is proper, the current in S1 will return to zero at the end of each mode, and an opportunity for opening the switch with zero loss is achieved. For $V_r = +V_{dc}$ ($k=1$) the first mode begins when S1 is closed, granted the condition $V_{co} < V_{dc}$ is met, and energy is transferred from the source to the capacitor. The capacitor voltage increases, hence this is called the charging mode. In the second mode $V_r = -V_{dc}$ ($k=-1$), the capacitor voltage must meet the condition $V_{co} < -V_{dc}$, and the inductor transfers energy from the capacitor back to the source. The capacitor voltage decreases, hence this is called the discharging mode. For the third mode $V_r = 0$ ($k=0$), the condition $V_{co} < 0$ must be satisfied, and a parallel resonance results. At the end of the resonant cycle the capacitor voltage has reversed its polarity and therefore this is called the polarity reversal mode. The fourth and final mode occurs when none of the previous three have been excited; the switch remains open and the capacitor linearly discharges. It becomes apparent that careful sequencing of the four possible modes allows regulation of the capacitor voltage, and consequently the ability to transfer power in either direction. This simple resonant principle is the fundamental concept behind the development of the ZCS converters described in this paper.

Having defined the constraints for energy transfer between the voltage source and current source, the possibility of replacing the current source I_0 with a VRM phase can now be considered. Since the values of the resonant circuit components are extremely small when compared to the VRM phase self inductance, the winding can be considered as a stiff current source for the duration of the resonant cycle. Thus, the preceding analysis remains valid. Through regulation of the capacitor voltage, the phase current can be controlled; a positive capacitor voltage will tend to increase the phase current while a negative voltage will reduce the current.

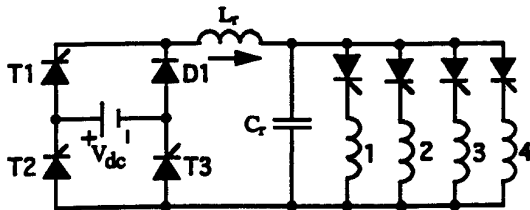

Fig. 4. Non-overlapping ZCS VRM converter topology for four phase VRM.

We first apply the above principle to what will be called the Non-overlapping DC link ZCS converter. Shown in Fig. 4, the simple circuit has a few devices and is in principle the same as in Fig. 3. Due to their natural zero current turn-off characteristics, low cost, and ruggedness, thyristors are the devices of choice. The charging mode is initiated by gating T1 and T3. The discharging mode is excited by gating T2 only. In this case T2 and D1 conduct and the surplus energy

in the capacitor is returned to the supply through a series resonant cycle. The polarity reversal mode is excited by gating T3 only. In this case T3 and D1 conduct and a parallel resonance is excited. When T1, T2, and T3 are off, the linear discharging mode results.

A proper control algorithm must choose the above modes sequentially in order to regulate the VRM phase current to a desired value, such that the turn-off time limitations of the thyristors are not violated and large resonant inductor currents are not allowed.

First, the thyristor turn-off time t_q can be considered. Fig. 5 illustrates typical wave forms produced by the circuit during one resonant cycle. The broken line represents the current which would naturally flow if allowed by the thyristors. In order for the devices to recover, the length of time that the current tends to be negative, θ in Fig. 5, must be greater than the thyristor turn-off time, t_q . Forcing this requirement on (5) yields

$$|k V_{dc} - V_{cd}| > Z_0 I_0 \tan\left(\frac{\omega_0 t_q}{2}\right) \quad (10)$$

The above constraint has a large impact on the practical choice of the resonant frequency. Furthermore, it implies that the initial capacitor voltage V_{co} must meet a minimum value requirement in order to avoid a commutation failure.

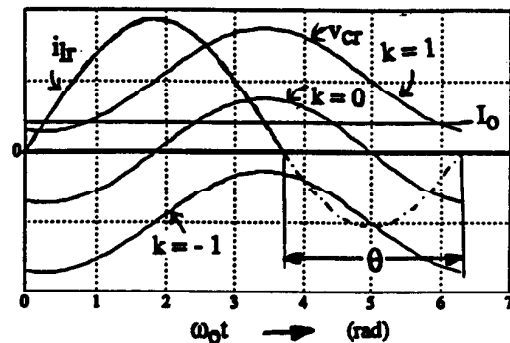

Fig. 5. Typical resonant current and voltage wave forms.

The capacitor voltage immediately prior to the initiation of a resonant cycle, V_{co} , is the key quantity for successful phase current regulation, and determines the peak current stress on the switching devices. The upper bound on this value is the commutation constraint determined from (10). The lower bound is selected to control the peak inductor current. Assume it is desired to limit the peak inductor current to α times the rated VRM phase current:

$$\alpha = \frac{I_{pkmax}}{I_{OR}} \quad (11)$$

From (5) the peak inductor current can be easily distinguished and bounded by (11) as follows:

$$I_{pk} = \sqrt{\left(\frac{(k V_{dc} - V_{co})}{Z_0}\right)^2 + I_0^2} + I_0 < I_{pkmax} \quad (12)$$

From (11) and (12) the following condition is obtained

$$|kV_{dc} - V_{co}| < Z_o \sqrt{\alpha^2 I_{oR}^2 - 2 \alpha I_{oR} I_o} \quad (13)$$

This lower bound on the initial capacitor voltage guarantees that the peak inductor current remains less than I_{pkmax} . These upper and lower boundaries set on V_{co} , result in the "allowed" switching regions in the capacitor voltage-load current plane as shown in Fig. 6. The point at which the commutation line and current limit curve meet must be sufficiently higher than the maximum phase current. This constraint gives a good estimate for the choice of the resonant capacitor and inductor values.

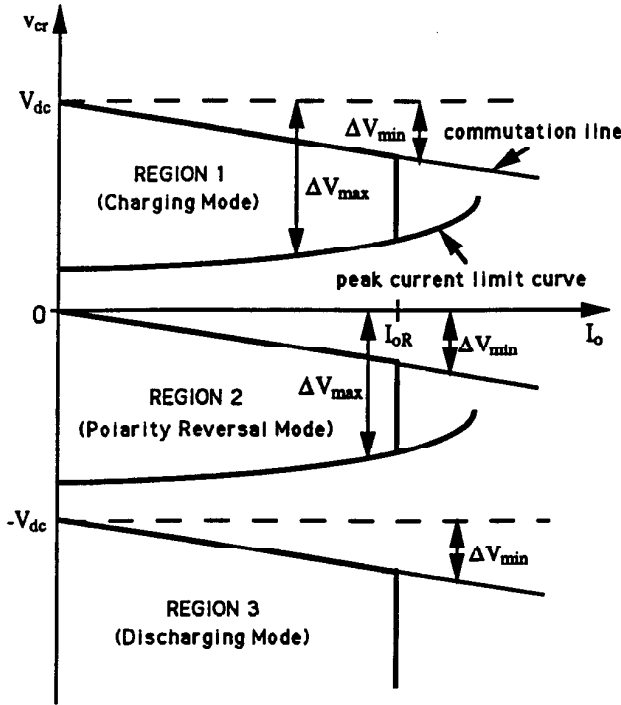

Fig. 6. Allowable switching regions of the ZCS resonant circuit.

Based on the value of the desired motor current, the instantaneous current value, and the capacitor voltage, from Fig. 6 the switching mode is selected. Such a switching algorithm is shown in Fig. 7. Discharging mode is selected when the capacitor voltage is within region 3. Charging mode is selected when the phase current is below the reference and the capacitor voltage is within region 1. The polarity reversal mode is selected when the capacitor voltage value is within region 2 and the reference current value is not decreasing. If none of these modes is selected due to the incompleteness of the defined conditions, the linear discharging mode results by default and the capacitor voltage decreases until it crosses one of the switching region boundaries. The appropriate mode is then selected. In this manner discrete resonant current pulses are programmed as shown in Fig. 8 in order to regulate the VRM phase current via the capacitor voltage.

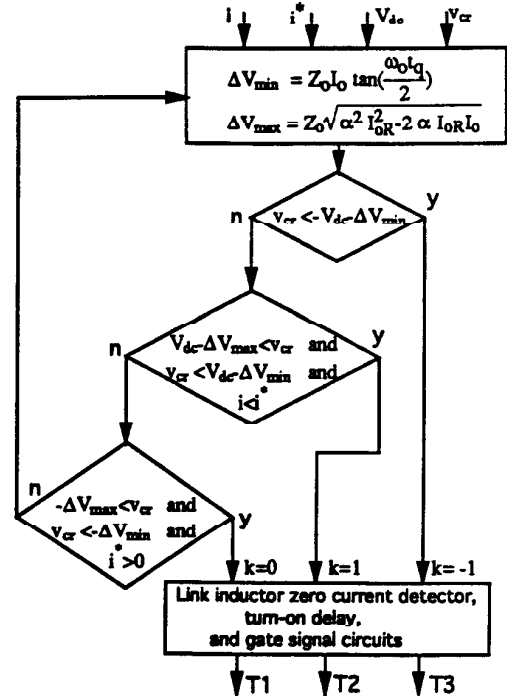

Fig. 7. Current regulation algorithm of the non-overlapping ZCS resonant converter.

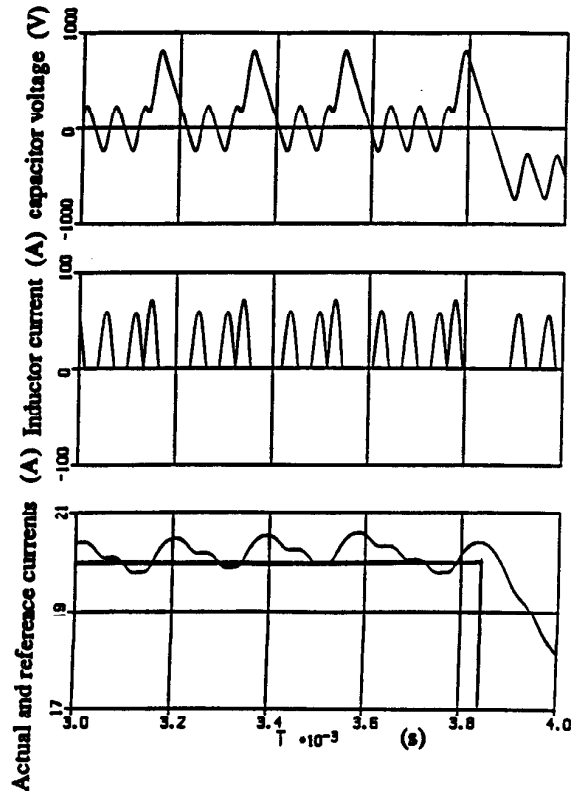

Fig. 8. Typical resonant capacitor voltage and inductor current, actual and desired VRM phase currents.

The control algorithm is simple and requires only the calculation of the switching region boundaries. It can be noted that the switching boundaries are slowly varying quantities dependent on the VRM phase currents, and can easily be calculated with the same microprocessor utilized to control the position, speed and torque of the machine.

The major drawback of the Non-overlapping converter topology is the impossibility of simultaneous conduction of two phase currents as the name suggests. This is so, because the same voltage is applied to all the VRM phases, yet the voltage polarity requirements are opposite in the off-going phase and on-going phase. The main VRM phase thyristors are gated only once every time the reference current is commanded and they naturally turn off at the zero crossing of the phase currents. Low cost and high efficiency make this topology a reasonable choice for low speed drives where phase current overlapping is not required. Power flow is bi-directional, and the VRM can be operated in all four quadrants.

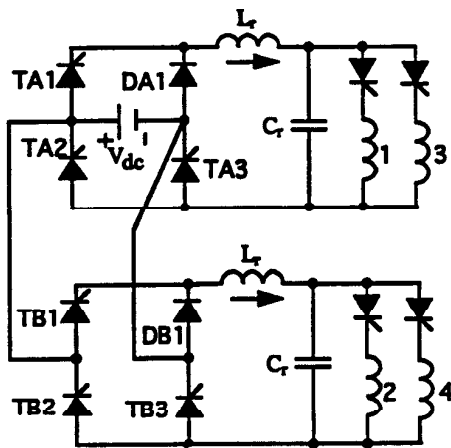

Fig. 9. Double-Link ZCS converter for 4 phase VRM

If desired, the topology in Fig. 4 can be modified to allow for phase current overlapping which can be crucial for high performance, high speed drives. The resulting topology is shown in Fig. 9. This topology can be used for VRMs with an even number of phases, and is particularly well suited for 4 phase machines which are one of the most popular VRM structures. The converter utilizes two resonant links, one for each of the non-adjacent phase groups. Being non-adjacent, these windings will not require overlap, and each link can independently program the desired current wave forms. In this topology the advance angle is limited to the step angle of the VRM, because if two non-adjacent phases overlap, the off-going phase current can not commutate for the same reason as in the non-overlapping converter. Although this topology requires twice as many resonant circuits and input bridges as in the Non-overlapping converter, it is capable of overlapping the phases for as much as the step angle; the full torque capability of the VRM can be utilized throughout a wide speed range. To regulate the VRM phase currents, the

control algorithm shown in Fig. 7 is employed exactly in the same manner as in the non-overlapping converter.

Shown in Fig. 10 is another topology that can be derived from Fig. 4 is the AC link ZCS converter. This converter again can operate only with even number of phases and is well suited for a four phase machine. For a three phase VRM the topology in Fig. 11 is required.

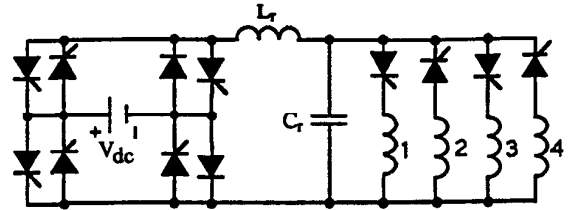

Fig. 10. AC Link ZCS converter for 4 phase VRM.

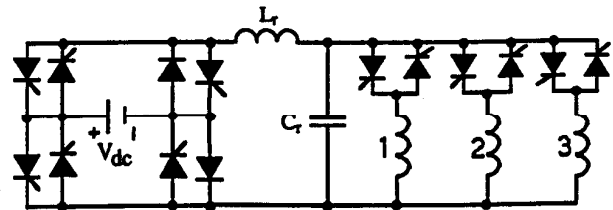

Fig. 11. AC Link ZCS converter for 3 phase VRM.

In the last two topologies the resonant inductor current must be allowed to flow in both directions, hence this current is AC and the converters consequently require twice as many switching devices in the input bridge as the DC link topologies. During non-overlapping intervals, the phase current is regulated in the same manner as the non-overlapping circuit. Hence the same operating modes are valid. At the beginning of overlap the off-going phase current is higher than the on-going phase current and while this condition persists the capacitor voltage must be kept within the allowed band. Some of the capacitor energy is directly utilized to build-up the on-going phase current while some is returned to the supply via the resonant link. As soon as the on-going phase current value exceeds the off-going phase current, the capacitor tends to positively bias the off-going phase current and decrease the on-going current. For this reason the resonant link must supply energy to the capacitor in order to maintain the proper voltage polarity in a manner to commutate the off-going phase and supply energy to the on-going phase.

When the on-going phase current reaches the desired value the off-going phase current may be non-zero. In this case, the off-going phase must have a sufficiently large average voltage in reverse polarity. Hence the capacitor voltage must be regulated to this voltage value until the off-going phase turns off. Since the on-going phase current is

close to the reference value, the capacitor voltage average value must be kept within allowed limits so that the on-going phase current does not exceed the reference value by a large amount. Therefore during this time there is a trade-off between the turn-off speed of the off going phase current, and the current error band of the on-going phase.

The sign of the algebraic sum of the two conducting phase currents determines the resonant inductor current flow direction, and its amplitude determines the allowed switching regions through the capacitor voltage - algebraic sum of the phase currents plane in the same manner as before. Hence, the required control algorithm is still simple and only requires a few more calculations than in the non-overlapping case. The advantage of the AC link topologies is that the resonant capacitor provides a direct path for energy transfer from the off-going phase to the on-going phase. This improves the commutation speed and energy efficiency of the system. In these topologies a simultaneous turn-off command to adjacent phases must be avoided, as they are connected in reverse parallel and can not be turned off at the same time. These unwanted effects can be avoided by proper choice of early turn-on and turn-off angles. Therefore, the accurate determination of early turn-on and turn-off angles are the key parameters to drive performance. Since the VRM phase currents in the last configuration are opposing one another, the flux in the machine is alternating, and this tends to increase the iron losses of the machine.

One advantage of the popular hard switched VRM converters is that the possibility for shoot-through currents does not exist. This benefit is retained in the ZCS topologies which have unidirectional resonant link currents (Non-overlapping and Double-link); there is no combination of thyristors which when simultaneously fired will short the DC bus. In the AC link topologies, however, the potential for shoot-through exists, and this must be considered when designing control circuitry.

4. ZCS CONVERTER VRM DRIVE SIMULATIONS

The Non-overlapping converter driving a 4 phase VRM was simulated at low speed and rated current using a constant speed, linear inductance model. The resonant frequency was selected as 20 kHz and for thyristors with 15 μ s turn-off time. The resonant inductor and capacitor values were designed in a manner to make the switching regions of Fig. 5 as wide as possible. The values were calculated as 1.3 μ F and 50 μ H. The DC bus voltage is assumed as 500 V and the rated current is 20 A. The VRM unaligned phase inductance is 10 mH and aligned phase inductance is 50 mH. At 500 RPM, the torque, phase currents, resonant inductor current and capacitor voltage wave forms are presented in Fig. 12. It is clear that the converter is capable of programming the desired phase currents accurately and efficiently. The maximum phase current ripple is 2 A peak to peak. For comparison a hard switched asymmetric bridge converter with 5 kHz switching frequency was simulated using the same motor, load, and DC bus voltage. A 6A maximum ripple was observed. This result illustrates the degree of improvement in regulating capability that can be achieved with ZCS converters. The inductor current and capacitor voltage are very well regulated as seen in the figure.

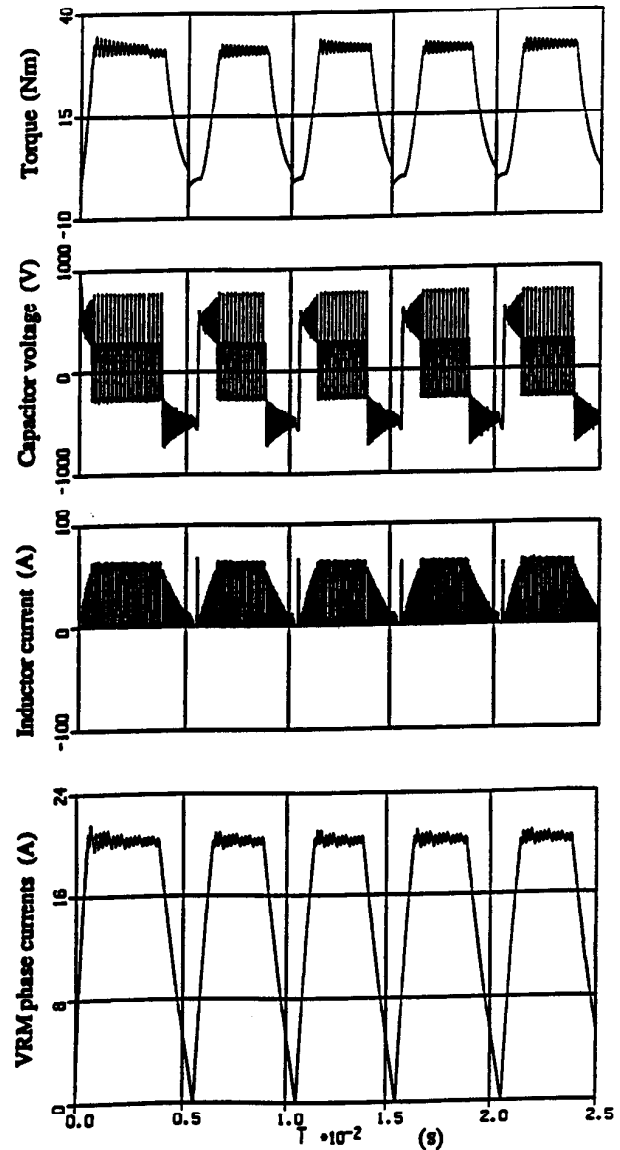

Fig. 12. Non-overlapping Converter Driven VRM drive simulation at 500 RPM and rated current.

The Double-link converter was also simulated for the same machine and load condition but at 1000 RPM. The results for this case are shown in Fig. 13. As expected, the freedom to overlap the phase currents results in less torque ripple. This topology possesses the widest overlapping angle capability among the ZCS converters proposed, hence it is suitable for high speed, high performance drives. For yet wider overlapping angles, the same converter can be utilized by designing the VRM geometry appropriately.

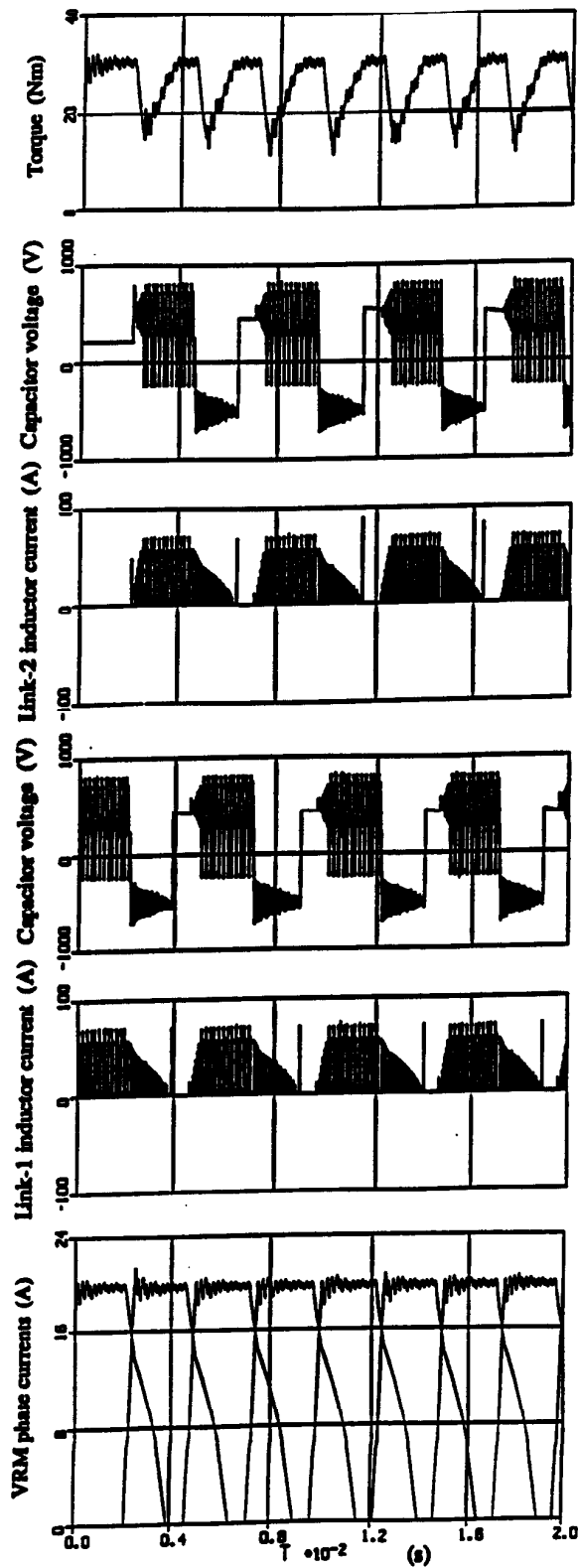

Fig. 13. Double-link ZCS converter drive simulation at 1000 RPM and rated current.

Finally, the AC link converter drive was simulated with the same parameters as before, and the results are presented in Fig. 14. Due to the direct energy transfer between the phases during overlap the resonant circuit has low a duty cycle. Hence the system efficiency is high. Both the Double-link converter and AC link converter can be operated at high speed as long as the turn off command is not given to two phases at the same time in the AC link converter, and two non adjacent phases are not conducting at the same time in the Double-link converter.

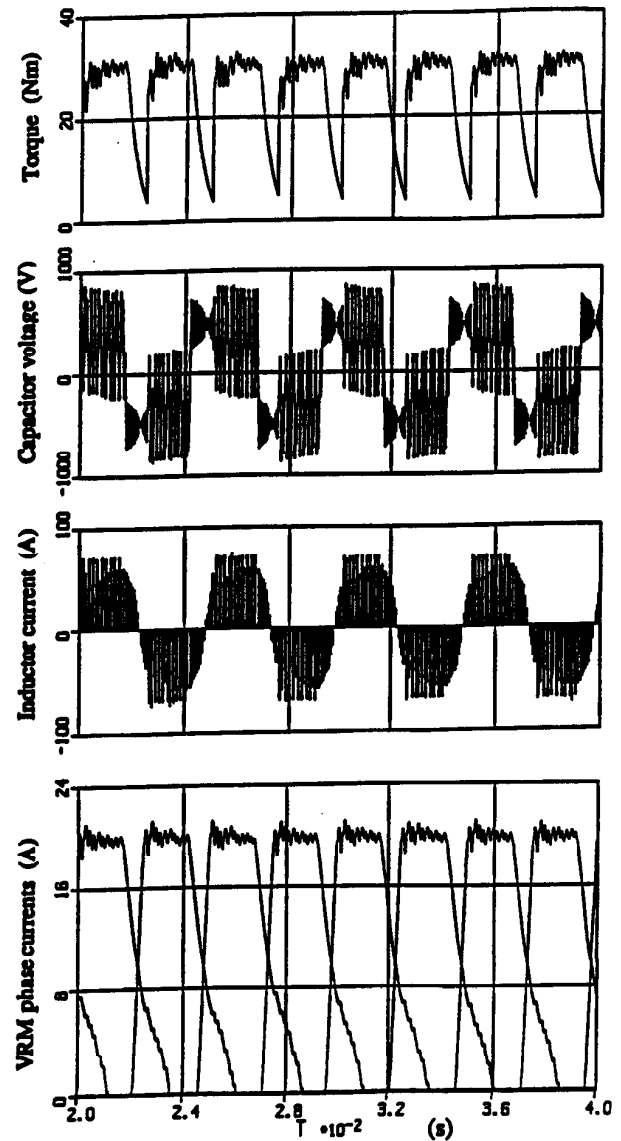

Fig. 14. Computer simulations of AC link ZCS converter drive at 1000 RPM and rated current.

At very high speed operation, the transition from current fed mode to voltage fed mode can successfully be achieved in all the proposed converters, provided that the overlapping limitations of the converters are not violated. Under these conditions, the converters can energize the VRM phases in a voltage fed mode. However, this operating condition is inferior to a hard switched converter during voltage fed operation, because in voltage fed operation excessive phase current build-up can not occur and high switching frequencies are not necessary. In the ZCS converter, the energy must flow through the resonant link. Hence the efficiency is lower than the hard switched converter. For this reason these resonant converters are not practical for VRM drives that primarily operate in voltage fed mode.

5. SWITCHING DEVICE CONSIDERATIONS

The ZCS topologies that have been introduced in this paper are attractive since they utilize thyristors which have important attributes such as low cost, low on state voltage drop, capability to withstand very high peak currents, and most importantly, natural commutation, i.e. having true zero current turn off characteristics.

The thyristors in series with the VRM phases are rated to the maximum VRM phase current and maximum capacitor voltage which is slightly less than twice the DC bus voltage. These devices operate at the frequency of the motor phase currents which is very low, typically no more than several hundred Hertz. Therefore the cost of these devices is low, and the conduction losses are also very low.

The ratings of the resonant thyristors, however, are relatively large. The peak currents are about four times the maximum motor phase currents while the voltage ratings are approximately three times the DC bus voltage. These devices must have a very short recovery time in order to allow for commutation at high resonant frequencies. Although the peak current ratings of thyristors is not an issue, the voltage ratings increase the cost of the devices. In all the topologies discussed there are at most three devices conducting at a time, hence the device conduction losses are low.

The total number of thyristors is minimum in the non-overlapping converter, and is equal to $3+N$ where N is the number of machine phases. In the AC link converter and the double link converter require three more thyristors in the resonant circuit.

6. CONCLUSIONS

Several new ZCS converter topologies have been introduced, their operating principles explained, and control algorithms developed. The excellent current regulating capability of these converters has been demonstrated by means of computer simulations. The simplicity of both the converter and control algorithm, and benefits of thyristors as switching devices are the other advantages of these converters. The switching losses are greatly reduced and the conduction losses are kept relatively small by limiting the peak inductor current value through the developed switching region control algorithm. Due to the nature of the resonance, the voltages and currents vary smoothly, resulting in reduced EMI and acoustic noise. Currently the proposed

converters are under construction and experimental results will be reported shortly.

REFERENCES

- [1] T.J.E. Miller, "Brushless Permanent-Magnet and Reluctance Motor Drives", Clarendon Press, Oxford, 1989.
- [2] T.J.E. Miller, J.M. Stephenson, S.R. MacMinn, J.R. Hendershot Jr., "Switched Reluctance Drives", Tutorial Course, IEEE Industry Applications Society, 1990.
- [3] T.J.E. Miller, "Converter Volt-Ampere Requirements of The Switched Reluctance Drive", Trans. IEEE on Ind. Appl., Vol. IA-21, 1985, pp. 126-136.
- [4] J.T. Bass, T.J.E. Miller, M. Ehsani and R.L. Steigerwald, "Development of a Unipolar Converter for Variable Reluctance Motor Drives", in Conf. Rec. IEEE IAS Annual Meeting, 1985, pp. 1062-68.
- [5] B.K. Bose, T.J.E. Miller, P.M. Szczesny and W.H. Bicknell, "Microcomputer Control of Switched Reluctance Motor", in Conf. Rec. IEEE IAS Annual Meeting, 1985, pp. 542-547.
- [6] W.F. Ray, P.J. Lawrenson, R.M. Davis, J.M. Stephenson, N.N. Fulton, R.J. Blake, "High Performance Switched Reluctance Brushless Drives", IEEE Trans. Ind. Appl. Soc., Vol. IA-22, July/August 1986, No.4, pp. 722-729.
- [7] A. Hava, V. Blasko, T.A. Lipo, "A Modified C-Dump Converter for Switched Reluctance Machines", IEEE Trans. Ind. Appl. Soc. Vol. IA-28, September/October 1992, No.5., pp. 1017-22.
- [8] S.S. Park, T.A. Lipo, "New Series Resonant Converter for Variable Reluctance Motor Drive", IEEE- PESC, June 1992, pp. 1-6.
- [9] R.W. De Doncker, J.P. Lyons, "An Auxillary Quasi-Resonant DC Link Inverter for Switched Reluctance Machines", European Conf. on Power Electronics and Applications, Firenze, Italy, 1991.
- [10] P.J. Lawrenson, "A Brief Status Review of Switched Reluctance Drives", EPE Journal, Vol. 2, no. 3., Oct. 1992, pp. 133-144.
- [11] P.P. Acarnley, R.J. Hill, and C.W. Hooper, "Detection of Rotor Position in Stepping and Switched Motors by Monitoring of Current Waveforms", IEEE Trans. Ind. Elect. Soc. Vol. IE-32, May/June 1985, No.3., pp. 215-222.
- [12] S.R. MacMinn, J.W. Sember, "Control of a Switched Reluctance Aircraft Engine Starter Generator Over a Very Wide Speed Range", IEEE Intersociety Energy Conversion Engineering Conference, Vol. 1, August 1989, pp. 631-637.
- [13] D.S. Schramm, B.W. Williams, T.C. Green, "A New Switched Reluctance Motor Drive Configuration", European Conf. on Power Electronics and Applications, Firenze, Italy, 1991, pp.394-397.