

Research Report
94 - 12

**Series Resonant DC Link Dual Converter
as a DC Motor Drive**

M. Yoshida*, H. Soebagia*, Y. Murai*, T.A. Lipo†

*Electronics & Computer Eng.
Gifu University
Japan

†Electrical & Computer Eng.
University of Wisconsin-Madison
Madison WI 53706-1691

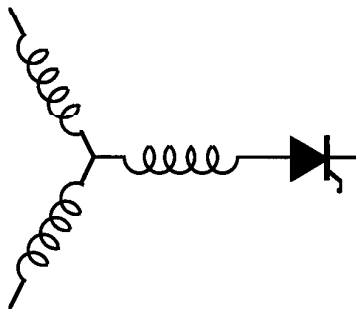

**Wisconsin
Electric
Machines &
Power
Electronics
Consortium**

University of Wisconsin-Madison
College of Engineering
Electrical & Computer Engineering Department
2559D Engineering Hall
1415 Johnson Drive
Madison WI 53706-1691

© May 1994 - Confidential

and current plane that are forward motoring, forward braking, reverse motoring, and reverse braking. Also this system provides the operation of motor current around zero region during no load operation. Therefore, the TRIAC can be applied as switching device to obtain a minimum number of device. The overall performance will be investigated by digital simulation. It will be shown that the input power factor can be improved (unity power factor), and the elimination of higher harmonics content and the high motor speed response with the variation of speed reference and load can be achieved. Experimental results of the system are also presented.

Comparative study between Conventional method and Series Resonant method

The performances of conventional (phase-control) and series resonant method are presented through digital simulation such as motor speed response, input power factor control, and harmonics content. In this case we use simple equivalent circuit of a DC motor and load model as shown in Fig.3 to make calculation easier.

Conventional method (Phase-control)

When the phase-control[5] is used to DC motor drives, the input voltage is applied to the DC motor during each half cycle. Fig.4(a) shows the input phase voltage v_{ain} , the input line current i_{ain} and the fundamental of i_{ain} in which shift angle ϕ is lagging to the v_{ain} . Fig.4(b) shows the harmonics content of input line current i_{ain} . Fig.5(a) shows the motor speed (Eg) response when Eg reference is changed from 150 V to 100 V at t_1 and it becomes steady after 10 ms at t_2 . Fig.5(b) shows the speed response when load resistance R_1 is changed at t_3 and it becomes steady after 20 ms at t_4 . In the figure, the constant speed is expected.

It can be cited as disadvantages of phase control that high harmonics content results, input power factor can not be controlled freely, and the motor speed response is slower than that of the series resonant method as shown later.

Series Resonant DC Link Full-bridge Converter.

Fig.1 shows three-phase full bridge resonant converter circuit utilized as a DC motor

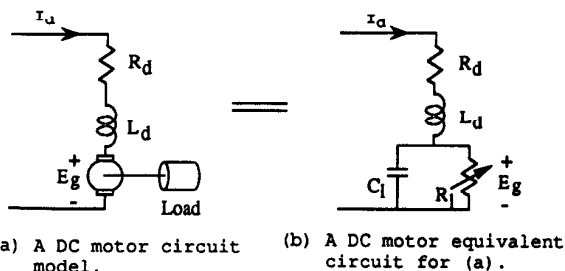

Fig.3 A DC motor equivalent circuit which utilized in simulation.

drives [2]. In the figure, capacitance C_0 and inductance L_0 form the series resonant circuit and those inductors L and capacitors C_L at the input are used for filtering high frequency components to get better waveform. The motor current I_d is superposed to the resonant current by the large inductance L_d . The inductance L_d includes motor inductance. R_d is the resistance included in inductance L_d .

The following equations and initial conditions can be derived from Fig.1:

$$-V_d + V_{C_0}(t) + V_{L_0}(t) + V_{sw}(t) = 0 \quad (1)$$

$$V_{C_0} = \frac{1}{C_0} \int_0^t i_o(t) dt = \frac{1}{C_0} \int_0^t (i_s(t) - I_d) dt \quad (2)$$

$$V_{L_0} = L_0 \frac{di_o}{dt} \quad (3)$$

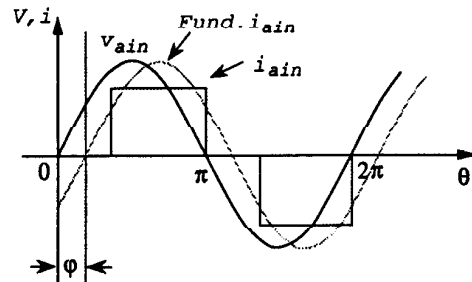

(a)

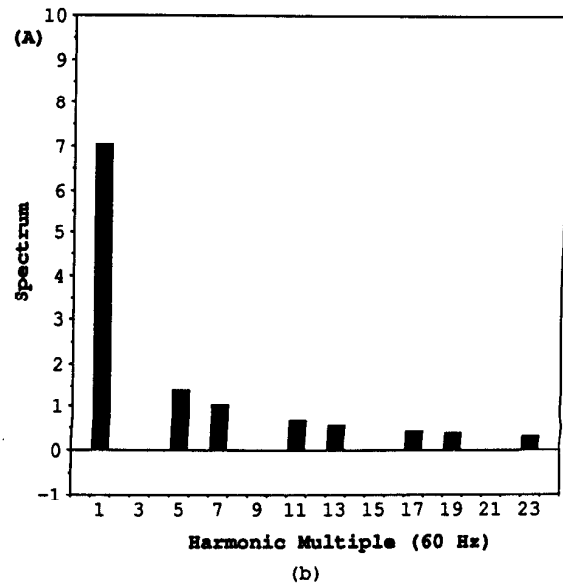

(b)

Fig.4: (a) Input phase voltage and input line current of phase control in which shift angle ϕ is lagging, (b) Harmonics content of input line current i_{ain} shown in (a).

Assume two thyristors T_a^+ and T_c^- as shown in Fig.1 are switched to the conducting state at $t=0$. If L_d is sufficiently large, the DC offset given by the current I_d is almost constant, the solutions of these differential equations are

$$V_{C_0}(0) = V_{C_0}, \quad i_s(0) = 0 \quad (4)$$

$$i_o(t) = (V_{sw}/Z_o)\sin\omega_0 t - I_d\cos\omega_0 t \quad (5)$$

$$i_s(t) = i_o + I_d$$

$$i_s(t) = (V_{sw}/Z_o)\sin\omega_0 t - I_d(1 - \cos\omega_0 t) \quad (6)$$

$$V_{C_0}(t) = V_d - V_{sw}\cos\omega_0 t - Z_o I_d \sin\omega_0 t \quad (7)$$

where,

$$\omega_0 = \frac{1}{\sqrt{L_o C_o}}, \quad Z_o = \sqrt{\frac{L_o}{C_o}}$$

$V_{sw} = V_d - V_{C_0}$; V_{C_0} : initial voltage across C_o

The resonant element and input filter parameters utilized in simulation are:

$$L_o = 20 \quad \mu H$$

$$C_o = 0.48 \quad \mu F$$

$$L = 5.00 \quad mH$$

$$C_L = 10.0 \quad \mu F$$

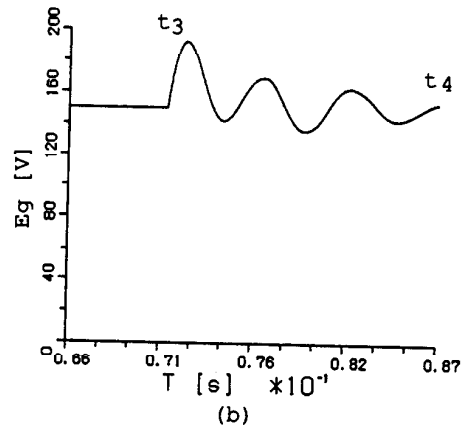
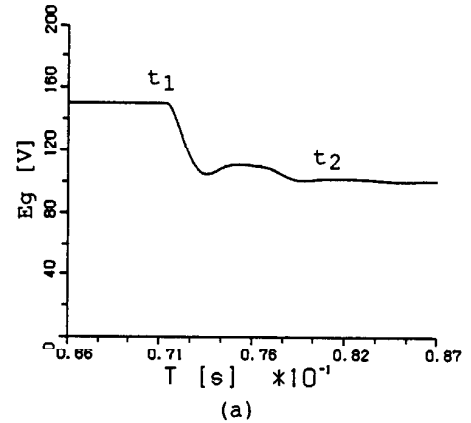

Fig.5 Motor speed response of phase control method
 (a) when E_g reference is changed from 150 V to 100 V,
 (b) when the load R_L is changed from 20Ω to 40Ω .

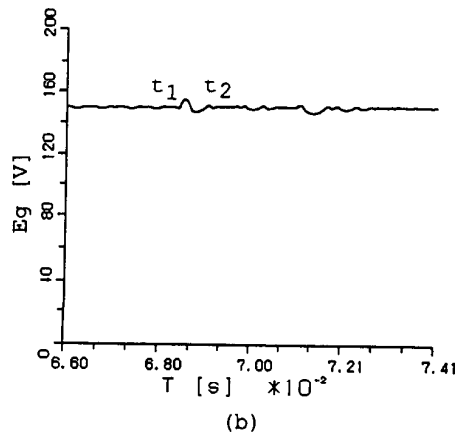
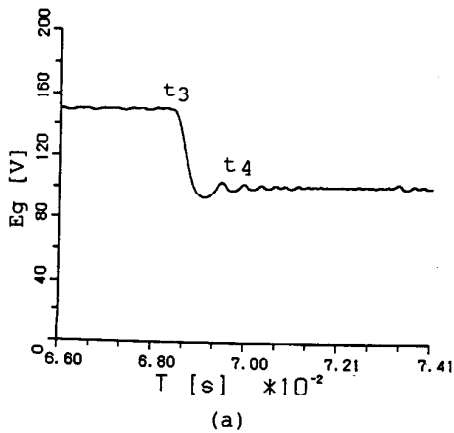

Fig.6 Motor speed response of resonant converter method,
 (a) when E_g reference is changed from 150 V to 100 V,
 (b) when the load R_L is changed from 20Ω to 40Ω .

40Ω at t_3 and it becomes steady after 0.5 ms at t_4 . The figures are compared with Fig.5(a), (b). It is cited as advantages of the series resonant method that the speed response is faster than that of phase control method.

In this system motor current I_d follows current reference I_d^* depending on the torque command. When no load torque is initiated, I_d should be operated around zero. However, the system in Fig. 1 had the problems that the system can work neither in no load condition nor in negative torque condition. Fig.7 shows the simulation result of the motor current I_d in Fig.1 when the current reference I_d^* is suddenly changed to zero at $t = 0$. In the figure, I_d can not be operated at average zero due to the inability of the system to generate negative current pulses. The other problem, the resonant current pulses i_s can not maintain high frequency switching. To improve this problem, we propose the series resonant DC link dual converter.

Control system utilized in Series Resonant DC Link Dual Converter

Fig.8 shows that the basic control structure of the system is constituted by a speed, torque and DC motor current loop. Motor current (I_d) and motor speed (ω) are measured and compared with reference quantities (I_{dref} and ω_{ref}) in the speed and current loops respectively. The error generated in the motor speed loop goes through a speed regulator and generates a current reference signal (I_{dref}) which is compared with the motor current I_d .

Fig.9(a) shows a simplified mono-phase equivalent circuit of the series resonant DC link dual converter as a DC motor drive. In the simplified circuit, the input of the resonant circuit is replaced by voltage

sources V_d and $-V_d$, and the thyristors are replaced by two thyristors connected in anti-parallel. When the forward converter makes positive resonant current pulses the reverse converter is blocked, while the reverse converter makes negative resonant current pulses, the forward converter stops, as shown in Fig.9(a) and (b), respectively. By doing this, the response of the motor current I_d is greatly improved as shown in Fig.10. The figure shows the variation of the motor current when the current reference I_d^* varies stepwisely from positive to zero, and from negative to zero.

The result of the input power factor control of this system utilizing the PID method is shown in Fig. 11. In Fig.11(a) i_{ain} is input line current, v_{ain} is input phase voltage, and the power factor is expected to be unity. Fig.11(b) shows harmonics content of i_{ain} in Fig.11(a). The harmonics content is almost eliminated.

Fig.12 shows the relation between i_{ain} and v_{ain} when the power factor is expected to be -1.

By applying the PID method to the input resonant converter, smooth ripple factor, fast response and low harmonics content can be achieved and input power factor can be controlled freely in wide range of operational load conditions.

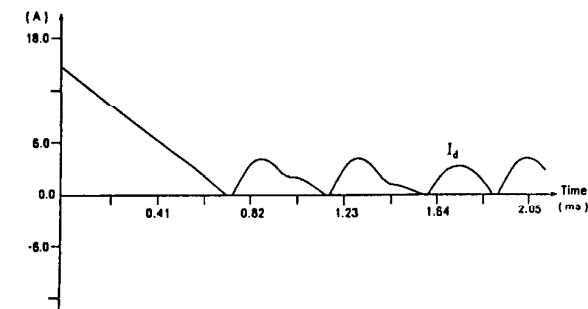

Fig.7 Motor current I_d when I_d^* steps to zero at $t=0$.

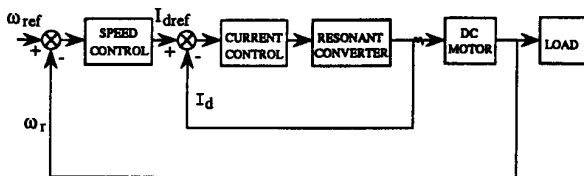

Fig.8 Block diagram of the control system.

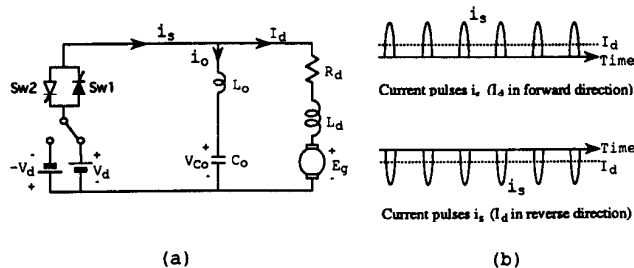

Fig.9 The monophase circuit of SRDCL Dual Converter and Resonant current pulses i_s .

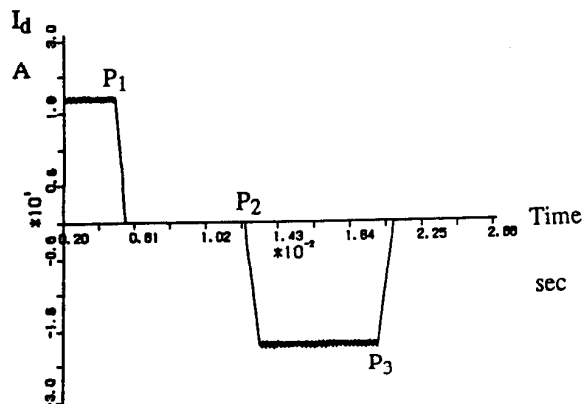

Fig.10 Response of I_d when current reference is changed stepwisely.

Experimental Results

The three phase experimental model has been assembled in our laboratory. The parameters of the system are as follows.

Resonant elements and bias inductance L_d :

$C_o = 0.9 \mu F$

$L_o = 21.4 \mu H$

$L_d = 5.0 mH$

Filter elements :

$L = 5.0 mH$

$C_L = 75.0 \mu F$

The motor used is a DC servo motor 2.3 kW, 1,000 rpm permanent magnet machine.

In this experiment, the maximum input power transfer method in which the maximum and the minimum of three phase input voltage are selected, is applied to the converter switching. Fig.13 shows the thyristor voltage and resonant current pulses when the AC input voltage is 100V. The switching frequency as high as 32 kHz is used in our experiment. Fig.14 shows the efficiency obtained by the experiment.

Conclusion

A series resonant DC link dual converter is proposed as a DC motor drive, and the following conclusions were reached :

1. In this system, the motor current can be operated in both forward and reverse direction, and also around zero current region .
2. The system has an advantage of fast response because high frequency of switching.
3. High efficiency was achieved in experiment because of zero current switching.
4. The minimum device will be achieved when TRIAC is utilized as switching device.

By implemented input power converter control, the input power factor can be controlled freely and the low harmonics content can be achieved dramatically.

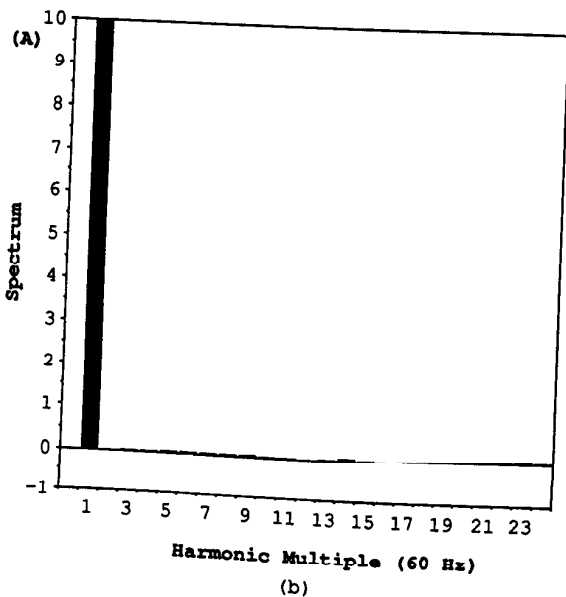
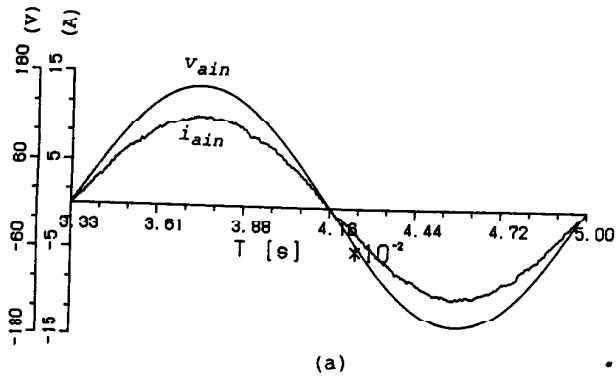

Fig.11: (a) Simulation results of Input phase voltage and input line current of Resonant converter method when power factor is expected to be unity, (b) Harmonics content of input line current i_{ain} shown in (a).

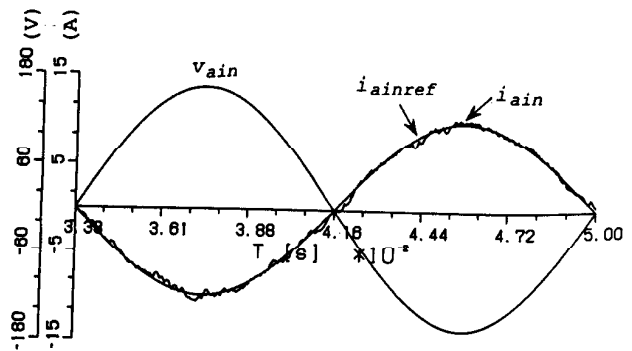

Fig.12 Input phase voltage v_{ain} and input line current i_{ain} when input power factor is expected to be -1.

References

- [1] Y. Murai and T. A. Lipo, "High Frequency Series Resonant DC Link Power Conversion", IEEE IAS Annual Meeting Conference Record, 1988, pp. 772 - 779.
- [2] D. M. Divan, "The Resonant DC Link Converter -- A New Concept in Static Power Conversion", IEEE-IAS Annual Meeting Conference Record, pp.648-656, 1987.
- [3] P. Sood and T. A. Lipo, "Power Conversion System Using a Resonant High Frequency AC Link", IEEE-IAS Annual Meeting Conference Record, pp.533-541, 1986.
- [4] P. Caldeira, K.W. Marschke, M.T. Aydemir, T. A. Lipo and Y. Murai, "Utilization of the Series Resonant DC Link as a DC Motor Drive", IEEE-IAS Conference Record, 1990, pp. 813 - 819.
- [5] F. R. Burgseth, S. S. Venkata, "Electric Energy Devices, " p.329, Prentice-Hall, Inc., 1987.

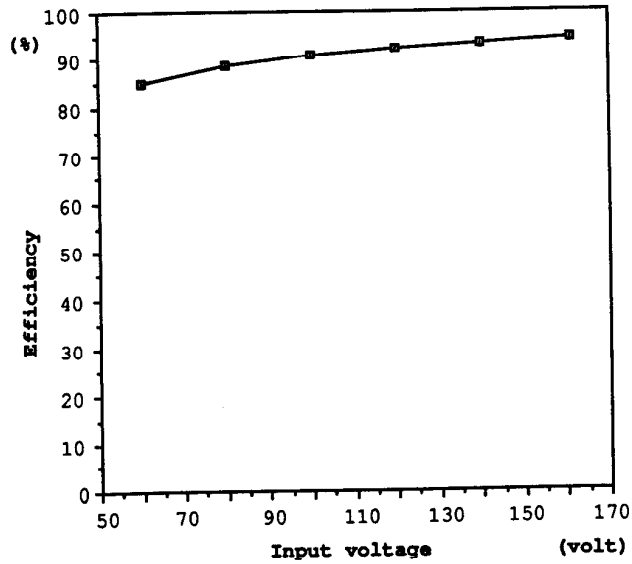

Fig.14 Efficiency of the experimental model

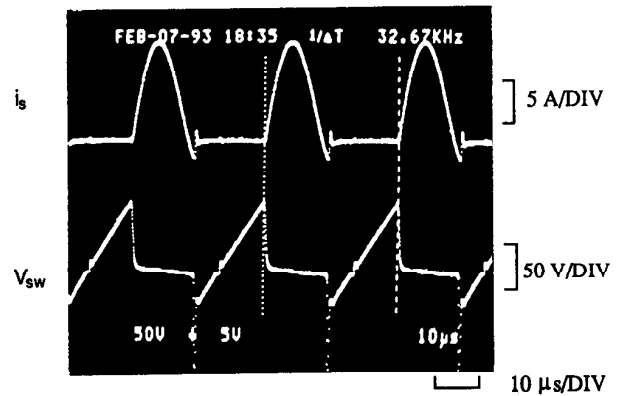

Fig.13 Waveforms of resonant current i_s and thyristor voltage V_{sw} .